



# CDVI

EN ENGLISH

FR FRANCAIS

**V1SR**  
**V3S**  
**V3SR**  
**V3SRB**  
**V4S**  
**V4SR**  
**V4SRB**  
**V5S**  
**V5SR**  
**V5SRB**



V1SR



V4S - V4SR - V4SRB



V3S - V3SR - V3SRB



V5S - V5SR - V5SRB

***Surface Mount Electromagnetic locks***  
***Ventouses électromagnétiques appliquées***

*The installer's choice*  
**cdvigroup.com**

TRENOIS  
DECAMPS

# V1SR - V3S - V3SR - V3SRB - V4S - V4SR - V4SRB - V5S - V5SR - V5SRB

## Surface mount Electromagnetic locks

*Thank you for buying our products and for the confidence you placed in our company.*

### 1] PRODUCT PRESENTATION

- **NFS 61-937.**
- **Surface mounting.**
- **High corrosion resistance.**
- **Safety rope.**
- **Delivered with armature.**
- **No mechanical wear.**
- **Ease of installation.**
- **Recommended for interior use.**
- **Positive safety (freas access immediately in the event of a power cut).**
- **Holding force:** 300/400/500kg.
- **Visual and audible signalling (see table)\*.**
- **No residual magnetism.**
- **Built-in electronic protection to eliminate back EMF.**

- Electromagnetic lock dimensions (L x W x D):
  - V1SR = 167 x 34 x 21mm.
  - V3S series = 254 x 45 x 27mm,
  - V4S series = 254 x 50 x 27mm,
  - V5S series = 272 x 66 x 40mm.
- Armature dimensions (l x w x d):
  - 180kg = 130 x 32 x 9mm,
  - 300kg = 185 x 38 x 11mm,
  - 400kg = 185 x 45 x 12mm,
  - 500kg = 185 x 60 x 12mm.
- Silent operation.
- Power supply: 12/24V dc.
- Power absorption:
  - 12 V DC = 500mA,
  - 24 V DC = 250mA.



The V3S, V4S and V5S series with signalling are suitable for the new regulations covering assistance to persons with reduced mobility.

Refs	Holding force	Visual feedback	Audible feedback	Relay	Monitored
V1SR	180 kg	-	-	-	✓
V3S	300kg		-	-	-
V3SR	300kg		-	✓	✓
V3SRB	300kg		✓	✓	✓
V4S	400kg		-	-	-
V4SR	400kg		-	✓	✓
V4SRB	400kg		✓	✓	✓
V5S	500kg		-	-	-
V5SR	500kg		-	✓	✓
V5SRB	500kg		✓	✓	✓

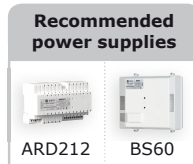

**COLOUR CODES**

- BLUE** ACTIVE VOLTAGE
- RED** LOCKED
- GREEN** OPEN
- BLUE** LOCKED
- GREEN** OPEN + BUZZER

### 2] REMINDERS AND RECOMMENDATIONS

The function of an electromagnetic lock is to ensure the locking of an access point. This document is a guide of installation which will allow you to secure the installation according to the characteristics of the product, the site and the environmental requirements.

\* Depending on the version.

# V1SR - V3S - V3SR - V3SRB - V4S - V4SR - V4SRB - V5S - V5SR - V5SRB

## Surface mount Electromagnetic locks

### APPROVAL RELATIVE TO EMERGENCY EXITS:

In the case of an installation of electromagnetic lock on emergency exits, it is imperative to make sure that these exit points will be automatically free in case of fire alarm, to open in the event of a fire alarm to allow evacuation of the premises. The electromagnetic lock installed on emergency exits must be in accordance with the fire approval department (Ex: In France = NF 61-937).

For more information, contact CDVI, the local fire officer or the safety officer responsible for the building.

### POWER SUPPLY

An electromagnetic lock always operates in DC current, a very low safety voltage. The Diax® electromagnetic lock is recommended for use with power supplies manufactured by CDVI, however, other power supplies may be used on condition that they are of equivalent quality and characteristics rectified, filtered, regulated and protected by fuse in primary and secondary sectors.

### MOUNTING RECOMMENDATIONS

- Define the level of security of the access.
- Determine the maximum strength of holding force to this level of security.
- Select the Diax® electromagnetic lock according to the environment, the inside, the outside, the climatic constraints, (For example: stainless steel dedicated to an outside use).
- Always install the electromagnetic lock on the secure side of the place to be secured.
- Indeed make sure that the frame and opening, receiving or supporting the electromagnetic lock, armature plate and their accessories, are solid and resistant to damage or wear over a period of time.
- Consider any bracketry required for the assembly according to the type of support receiving the electromagnetic lock and armature plate.
- Define the passage of cables to ensure the protection against the vandalism and the environmental requirements (in particular through flexible hoses of door, glands, gutters, cross cables, plastic tubes).

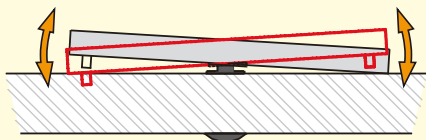

### Armature plate

- It is vital to fix the electromagnetic lock and armature plate solidly on their supports.
- Make sure that the magnet and the armature meet evenly over their entire mating surfaces.
- The Armature plate must be able to pivot slightly about its center mounting screw to compensate for any door misalignment.

### Security ropes

The electromagnetic lock undergoes repeated shocks and the vibration at the points of fixation on the frame (frequencies of openings / closures, attempt of opening wears closed and attempts of vandalism) which can loosen the fixing bolts/ screws. To prevent the risk of the electromagnetic lock from falling, install both security ropes supplied, to guarantee the safety of the users (see attached plan).

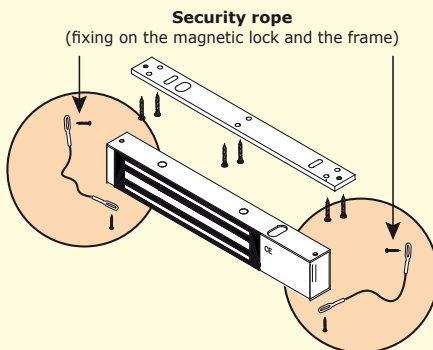











**V1SR - V3S - V3SR - V3SRB - V4S - V4SR - V4SRB - V5S - V5SR - V5SRB**  
*Surface mount Electromagnetic locks*

**MAINTENANCE**

















The Electro magnet and armature plate have a specific treatment which strengthens the protection against wear and corrosion. These products do not require high maintenance. Nevertheless to ensure optimum performance, it is recommended to clean regularly the surfaces in contact of the electro magnet and armature plate with a cloth and non abrasive products. If traces of corrosion appear, it is recommended to clean and oil the contact surfaces. Check and tighten regularly all the fixings of the Electro magnet and ensure that while the armature is able to pivot on its mounting, the fixing bolt is not liable to loosen (we recommend thread-lock for all fixing bolts).

**3] PACKAGE CONTENTS**

**ELECTROMAGNETIC LOCK V1SR**

										
Surface mount magnetic lock	Armature plate	Fixing plate	Roll pin 5x16	Steel washer	3x25 wood screw	Key 3mm	Guide piece	Cap nut	Installation manual	M5x20 screw
1	1	1	2	2	5	1	1	1	1	1

**ELECTROMAGNETIC LOCK V3S - V3SR - V3SRB - V4S - V4SR - V4SRB - V5S - V5SR - V5SRB**

							
Surface mount magnetic lock	Armature plate	Fixing plate	Roll pin 5x16	Steel washer	4x25 wood screw	Key 3mm	Key 5mm
1	1	1	2	2	7	1	1
							
M8x35 screw	M8x25 screw	3x8 self-tapping screw	Guide piece	Cap nut	Safety rope	Rubber washer	Installation manual
1	1	1	1	1	2	1	1

**V1SR - V3S - V3SR - V3SRB - V4S - V4SR - V4SRB - V5S - V5SR - V5SRB**  
*Surface mount Electromagnetic locks*

**4] OPTIONAL ACCESSORIES**

<b>References</b>	L3L4L5	Z3Z4Z5	UBKU	UBKP	AMA3AMA5	DPM300 DPM500	LZ1
<b>Description</b>	L-shaped bracket for lock	Z-shaped bracket for lock	Armature base for glass door	Universal base for glass door	Armature base	Door position monitoring	L & Z-shaped bracket for 180kg lock

**5] ELECTRICAL CONNECTIONS**

TERMINAL BLOCK	CORRESPONDENCE	V3S V4S - V5S	V3SR - V3SRB - V4SR V4SRB - V5SR - V5SRB
+	12 or 24V dc	■	■
-	- 0 V	■	■
N.C	NC (Normally closed)	-	■
COM	COM	-	■
N.O	NO (Normally open)	-	■



**12V dc  
Factory  
Setup**

The NO/NC signal only switches when the door is closed with the power to it on.

**WITH BUILT-IN PCB BOARD**

**V3S - V4S - V5S**

**V3SR - V4SR - V5SR**

**V3SRB - V4SRB - V5SRB**

*Voltage selection jumpers*

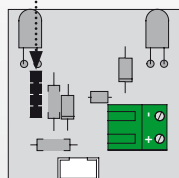
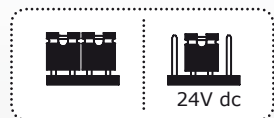

*Voltage selection jumpers*

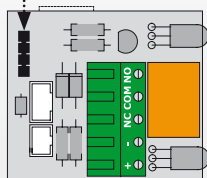
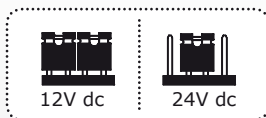

*Voltage selection jumpers*

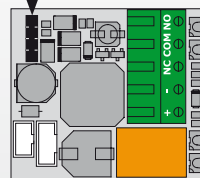
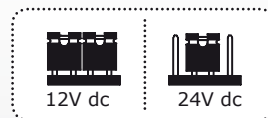

**V1SR - V3S - V3SR - V3SRB - V4S - V4SR - V4SRB - V5S - V5SR - V5SRB**  
 Surface mount Electromagnetic locks

**DIRECT CONNECTION**

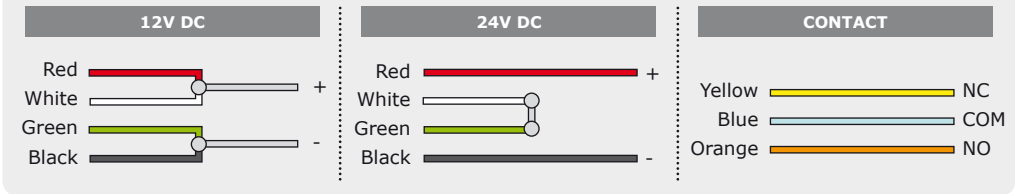

**IMPORTANT NOTE**

**Check the jumper position before connecting the lock to the input current. A wrong position could damage the lock. This type of damage is not covered by the warranty.**

**6] INSTALLATION (EXAMPLE: V3S SERIES)**

**Installation on an outward opening door (Push door)**

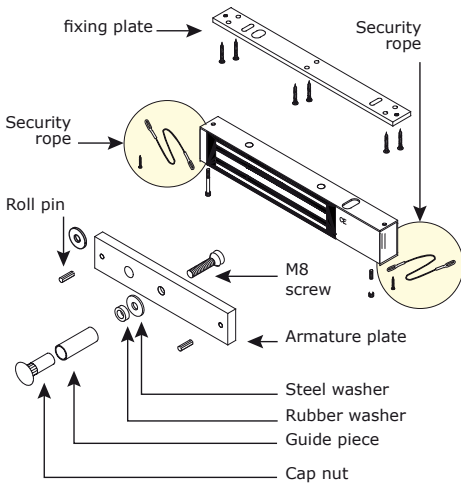

**OUTSIDE**

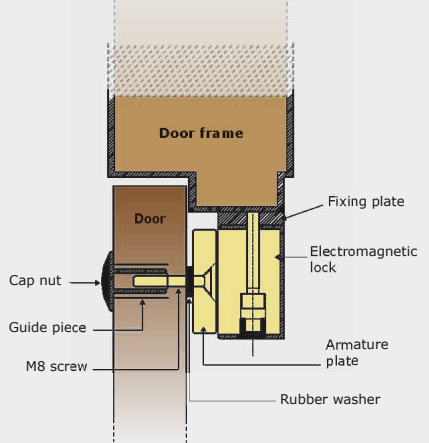

**Outwards opening door (push door).**

**V1SR - V3S - V3SR - V3SRB - V4S - V4SR - V4SRB - V5S - V5SR - V5SRB**  
*Surface mount Electromagnetic locks*

**Installation on an inward opening door (Pull door)**

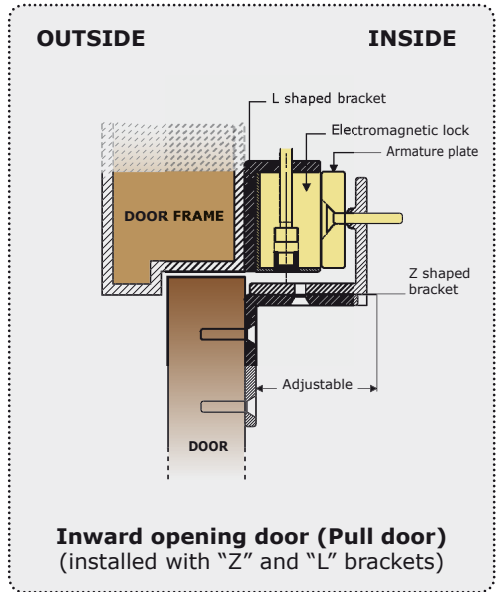
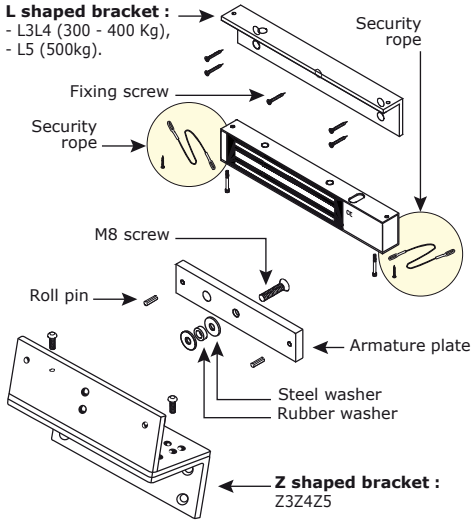

**7] INSTALLATION WITH ACCESSORIES**

**Installation with an Armature housing**

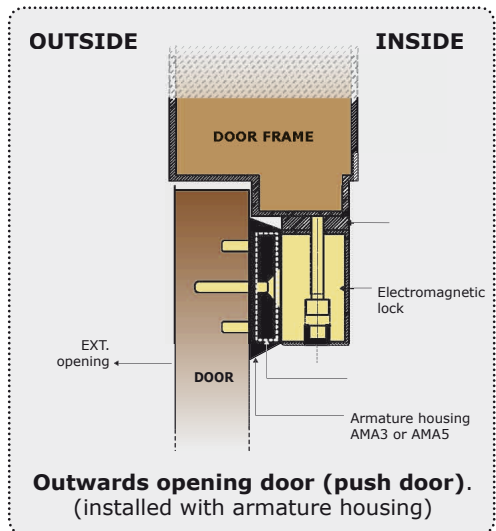
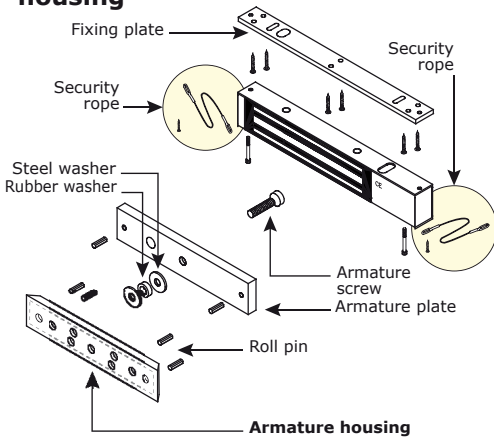

**V1SR - V3S - V3SR - V3SRB - V4S - V4SR - V4SRB - V5S - V5SR - V5SRB**  
 Surface mount Electromagnetic locks

**Installation with base for glass door**

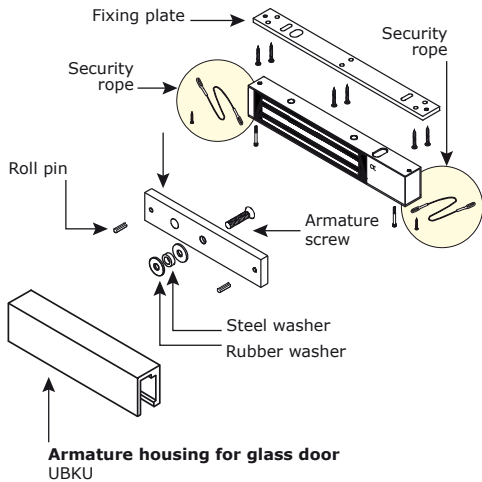

**OUTSIDE**

**INSIDE**

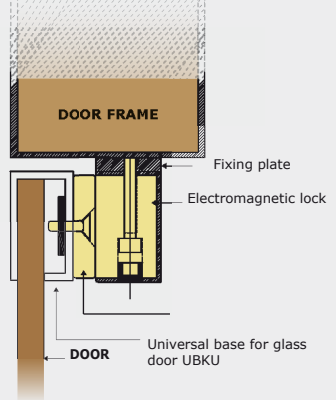

**Outward opening door (Push door)**  
 (installed with UBKU brackets)

**Installation with base for glass door**

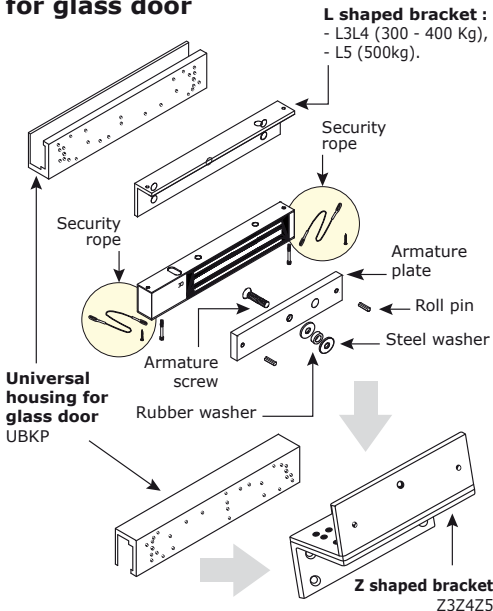

**OUTSIDE**

**INSIDE**

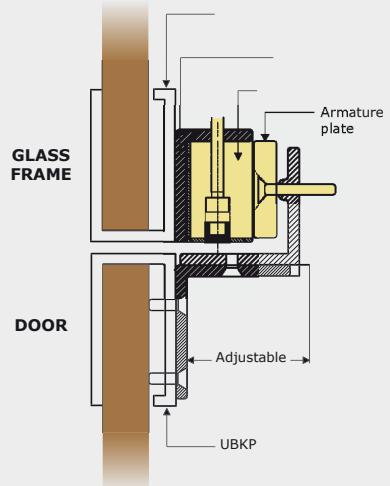

**Inward opening door (Pull door)**  
 (installed with "UBKP", "L3L4L5"  
 and Z3Z4Z5 brackets)



**V1SR - V3S - V3SR - V3SRB - V4S - V4SR - V4SRB - V5S - V5SR - V5SRB**  
*Surface mount Electromagnetic locks*

**Installation with DPM300 - DPM400 - DPM500 (Door position monitoring)\***

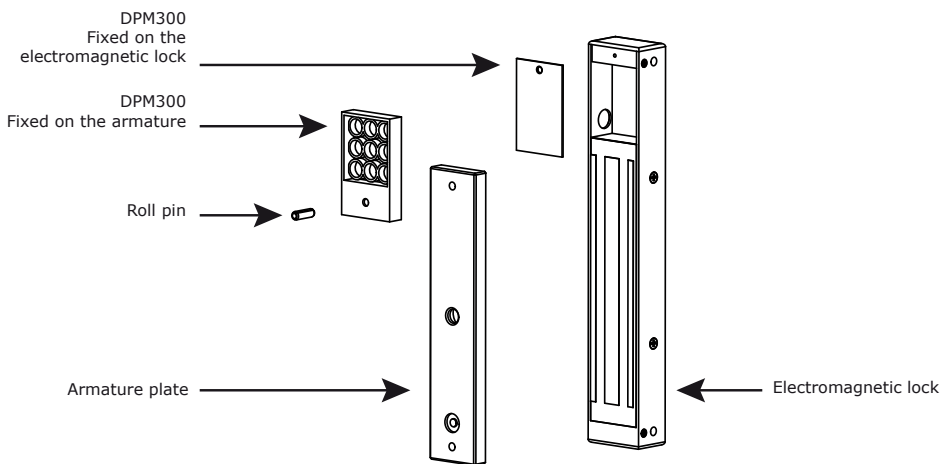

**8] FAULT FINDING**

PROBLEM	POSSIBLE CAUSE	SOLUTION
<b>Door locking impossible</b>	The lock is not receiving DC current.	<ul style="list-style-type: none"> <li>- Check that the wires are connected to the right terminals.</li> <li>- Check that the power supply is compatible.</li> <li>- Check that the lock is connected to the circuit correctly.</li> </ul>
<b>Holding force reduced</b>	The lock and the armature are not lined up with each other.	<ul style="list-style-type: none"> <li>- Check that the lock is connected to the circuit correctly.</li> <li>- Check that the electromagnet and the armature are properly aligned.</li> <li>- Check that the contact faces are free from dirt and rust.</li> <li>- Check that the armature is soft mounted.</li> </ul>
	Low voltage or armature jammed.	<ul style="list-style-type: none"> <li>- Check that the lock is receiving the correct power supply satisfactorily.</li> <li>- check the tightening of the armature and the condition of the rubber.</li> </ul>
<b>Faulty reed switch</b>	Voltage too low. Misalignment.	<ul style="list-style-type: none"> <li>- Check the power supply.</li> <li>- Cable cross section to be determined according to the power supply and the locking.</li> <li>- e.g.: <math>2 \times 1.5\text{mm}^2 \geq 10\text{m}</math>.</li> </ul>

\* Optional. Sold separately.



**V1SR - V3S - V3SR - V3SRB - V4S - V4SR - V4SRB - V5S - V5SR - V5SRB**  
*Ventouses électromagnétiques appliques*

**Merci pour l'achat de ce produit et pour la confiance que vous accordez à notre entreprise.**

**1] PRESENTATION PRODUIT**

- **Applique\***.
- **1 relais\***.
- **Signal\***.
- **Signalisation lumineuse et sonore\***.
- **Force de rétention** : 180, 300, 400 ou 500 kg\*.
- **NFS 61-937**.
- **Filin de sécurité\***.
- **Haute résistance à la corrosion**.
- **Livrée avec contre-plaque**.
- **Pas d'usure mécanique**.
- **Facilité d'installation**.
- **Installation en intérieur**.
- **Sécurité positive**  
*(libère instantanément l'accès en cas de coupure de courant)*.
- **Pas de magnétisme résiduel**.
- **Varistance incorporée** : Protection électronique intégrée contre l'effet de self.
- Dimensions des ventouses (L x l x P) :
  - V1SR = 167 x 34 x 21 mm,
  - Gamme V3S = 254 x 45 x 27 mm,
  - Gamme V4S = 254 x 50 x 27 mm,
  - Gamme V5S = 272 x 66 x 40 mm.
- Dimensions des contre-plaques (L x l x P) :
  - 180 kg = 130 x 32 x 9 mm,
  - 300 kg = 185 x 38 x 11 mm,
  - 400 kg = 185 x 45 x 12 mm,
  - 500 kg = 185 x 60 x 12 mm.
- Fonctionnement silencieux.
- Alimentation : 12/24 V DC.
- Consommation :
  - 12 V DC = 500 mA,
  - 24 V DC = 250 mA.



Les gammes V3S, V4S et V5S avec signalisation sont adaptées à la nouvelle réglementation relative aux personnes à mobilité réduite.

Refs	Force de rétention	Leds	Buzzer	Relais	Signal
V1SR	180 kg	-	-	-	✓
V3S	300 kg		-	-	-
V3SR	300 kg		-	✓	✓
V3SRB	300 kg		✓	✓	✓
V4S	400 kg		-	-	-
V4SR	400 kg		-	✓	✓
V4SRB	400 kg		✓	✓	✓
V5S	500 kg		-	-	-
V5SR	500 kg		-	✓	✓
V5SRB	500 kg		✓	✓	✓

**CODES COULEURS**

- BLEU** TENSION ACTIVE
- ROUGE** VERROUILLÉ
- VERT** OUVERT
- BLEU** VERROUILLÉ
- VERT** OUVERT + BUZZER

**Alimentations préconisées**

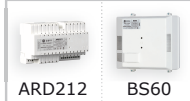

ARD212

BS60



DEEE



IP42



Certification CE



RoHS

\* Selon version.

**V1SR - V3S - V3SR - V3SRB - V4S - V4SR - V4SRB - V5S - V5SR - V5SRB**  
*Ventouses électromagnétiques appliquées*

**2] RAPPELS ET RECOMMANDATIONS**

La fonction d'une ventouse électromagnétique est d'assurer le verrouillage d'un accès. Ce document est un guide de pose qui vous permettra de sécuriser l'installation en fonction des caractéristiques du produit, du site et des contraintes environnementales.

**NORME INCENDIE RELATIVE AUX ISSUES DE SECOURS**

Dans le cas d'une installation de ventouses électromagnétiques sur des issues de secours, il est impératif de s'assurer que ces accès seront automatiquement libres en cas d'alarme incendie, pour permettre une évacuation des lieux. Les ventouses électromagnétiques installées sur des issues de secours doivent impérativement être conforme à la norme incendie locale (Ex : En France = NFS 61-937).

*Pour plus d'informations, rapprochez-vous de CDVI, de l'organisme certifié local ou du centre de sécurité du bâtiment.*

**ALIMENTATION**

Une ventouse électromagnétique fonctionne toujours en courant continu, impérativement en très basse tension de sécurité (TBTS). Les ventouses électromagnétiques Diax® sont préconisées avec les alimentations de la gamme CDVI, toutefois, d'autres alimentations peuvent être utilisées à la condition que celles-ci présentent une qualité et des caractéristiques équivalentes, notamment redressée, filtrée, régulée, protégé par fusible en primaire et secondaire...

**CONSEIL D'INSTALLATION**

- Définir le niveau de sécurité de l'accès.
- Adapter la force de rétention maximum à ce niveau de sécurité.
- Sélectionner la ventouse électromagnétique Diax® en fonction de l'environnement, intérieur, extérieur, contraintes climatiques, ... (Par exemple : inox dédiée à une utilisation extérieure).
- Installer toujours la ventouse à l'intérieur du lieu à sécuriser.
- Bien s'assurer que le dormant et l'ouvrant, recevant ou supportant la ventouse, la contre-plaque et leurs accessoires, soient solides et résistants dans le temps.
- Adapter les éléments de montage en fonction du type support recevant la ventouse et la contreplaque (visserie, chevilles, accessoires,...).
- Définir le passage des câbles pour en assurer la protection contre le vandalisme et les contraintes environnementales (notamment par l'intermédiaire de flexibles de porte, presse-étoupe, goulottes, passe câbles, tubes plastiques, ...).

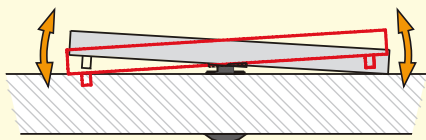

**La contre-plaque**

- Il est vital de fixer solidement la ventouse et la contreplaque sur leurs supports.
- Mettre en vis-à-vis la ventouse et sa contreplaque pour optimiser la force de rétention.
- La contreplaque doit être montée "flottante", pour compenser un mauvais alignement de la porte.

**Les fils de sécurité**

La ventouse électromagnétique subit tout au long de sa vie une accumulation de chocs répétés et de sollicitations aux niveaux des points de fixation sur le dormant, fréquences d'ouvertures/fermetures, (tentative d'ouverture porte verrouillée et tentatives de vandalisme) ce qui peut générer sa désolidarisation du support au moment de l'ouverture. Afin de pallier au risque de chute du bloc ventouse, installer les deux fils de sécurité fournis pour garantir la sécurité des utilisateurs (voir schéma).

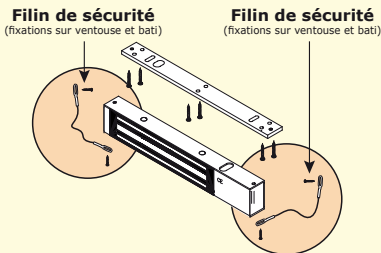











**V1SR - V3S - V3SR - V3SRB - V4S - V4SR - V4SRB - V5S - V5SR - V5SRB**  
*Ventouses électromagnétiques appliques*

**ENTRETIEN**

















La ventouse et sa contreplaque disposent d'un revêtement spécifique qui renforce la protection contre l'usure et la corrosion. Ces produits nécessitent donc peu d'entretien. Néanmoins pour assurer une fonctionnalité optimum, Il est recommandé de nettoyer régulièrement les surfaces en contact de la ventouse et de sa contreplaque avec un chiffon et produits non abrasifs. Si des traces de corrosion venaient à apparaître, il est recommandé de nettoyer et huiler légèrement ces mêmes surfaces en contact. Vérifier et resserrer régulièrement l'ensemble des fixations de la ventouse. Il est nécessaire de mettre un frein-filet sur la vis pivot de la contreplaque.

**3] ÉLÉMENTS INCLUS**

**VENTOUSES V1SR**

										
<b>Ventouse saillie</b>	<b>Contre-plaque</b>	<b>Plaque de montage</b>	<b>Goupille 5x16</b>	<b>Rondelle acier</b>	<b>Vis M5x20</b>	<b>Vis bois 3x25</b>	<b>Clef 3 mm</b>	<b>Embout de guidage</b>	<b>Ecrue borgne</b>	<b>Notice</b>
1	1	1	2	2	1	5	1	1	1	1

**VENTOUSES V3S - V3SR - V3SRB - V4S - V4SR - V4SRB - V5S - V5SR - V5SRB**

							
<b>Ventouse saillie</b>	<b>Contre-plaque</b>	<b>Plaque de montage</b>	<b>Goupille 5x16</b>	<b>Rondelle acier</b>	<b>Vis bois 4x25</b>	<b>clef 3 mm</b>	<b>clef 5 mm</b>
1	1	1	2	2	7	1	1
							
<b>Vis M8x35</b>	<b>Vis M8x25</b>	<b>Vis autoforeuse 3x8</b>	<b>Embout de guidage</b>	<b>Ecrue borgne</b>	<b>Filin de sécurité</b>	<b>Rondelle caoutchouc</b>	<b>Notice</b>
1	1	1	1	1	2	1	1

**V1SR - V3S - V3SR - V3SRB - V4S - V4SR - V4SRB - V5S - V5SR - V5SRB**  
*Ventouses électromagnétiques appliquées*

**4] ACCESSOIRES EN OPTION**

<b>Références</b>	<b>L3L4 (300KG)</b> <b>L5 (500KG)</b>	<b>Z3Z4Z5</b>	<b>UBKU</b>	<b>UBKP</b>	<b>AMA3 (300KG)</b> <b>AMA5 (500KG)</b>	<b>DPM300</b> <b>DPM500</b>	<b>LZ1</b>
<b>Description</b>	Support en "L" pour ventouse (300,400 & 500kg)	Support en "Z" pour ventouse (300,400 & 500kg)	Support de contre-plaque pour porte en verre (300,400 & 500kg)	Support universel pour porte en verre (300,400 & 500kg)	Support de contre-plaque (300 & 500kg)	Contact de position de porte (300 & 500kg)	Kit L & Z Pour V1SR (180 kg)

**5] RACCORDEMENT**

BORNIER	CORRESPONDANCE	V3S V4S - V5S	V3SR - V3SRB - V4SR V4SRB - V5SR - V5SRB
<b>+</b>	12 or 24 V DC	■	■
<b>-</b>	- 0 V	■	■
<b>N.C</b>	NC (Normalement fermé)	-	■
<b>COM</b>	COM	-	■
<b>N.O</b>	NO (Normalement ouvert)	-	■



**12 V DC**  
**Réglage usine**

Le signal NO/NC ne commute que lorsque la porte fermée et sous tension.

**AVEC ÉLECTRONIQUE DÉPORTÉE**

**V3S - V4S - V5S**

*Cavaliers de sélection de la tension*

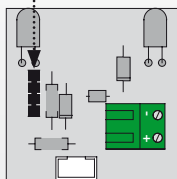
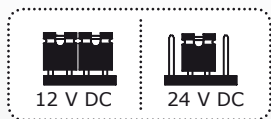

**V3SR - V4SR - V5SR**

*Cavaliers de sélection de la tension*

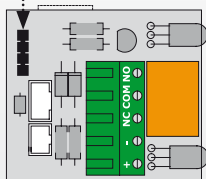
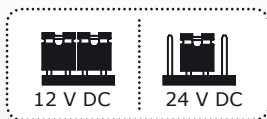

**V3SRB - V4SRB - V5SRB**

*Cavaliers de sélection de la tension*

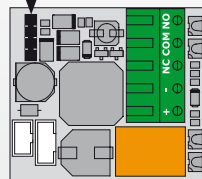
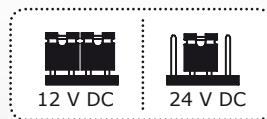

**V1SR - V3S - V3SR - V3SRB - V4S - V4SR - V4SRB - V5S - V5SR - V5SRB**  
*Ventouses électromagnétiques appliques*

**CONNEXION DIRECTE**

12 V DC

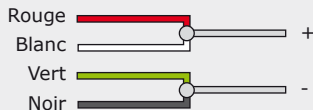

24 V DC

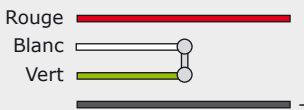

CONTACT



**NOTE IMPORTANTE**

**Vérifier la position du cavalier avant de brancher la ventouse au courant d'entrée. Une position incorrecte peut endommager la ventouse. Ce type de dommage n'est pas couvert par la garantie.**

**6] MONTAGE (EXEMPLE: GAMME V3S)**

**Montage sur porte à ouverture extérieure (Poussante)**

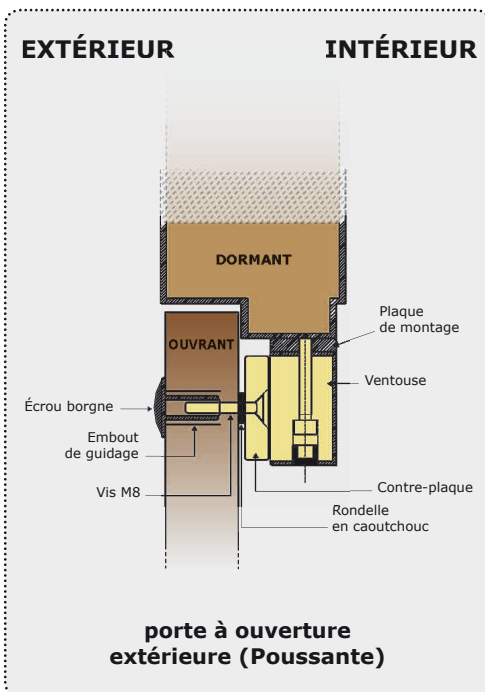
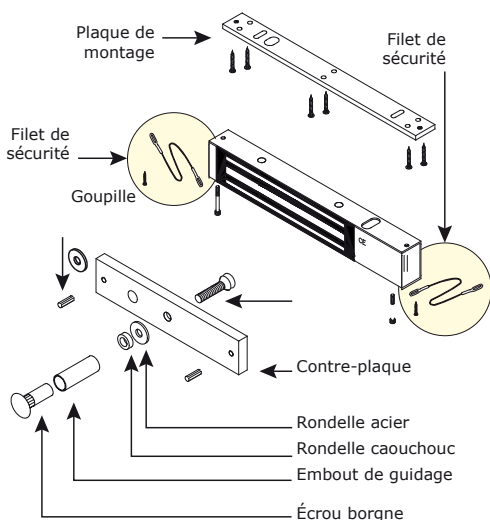

V1SR - V3S - V3SR - V3SRB - V4S - V4SR - V4SRB - V5S - V5SR - V5SRB  
 Ventouses électromagnétiques appliquées

**Montage sur porte à ouverture intérieure (Tirante)**

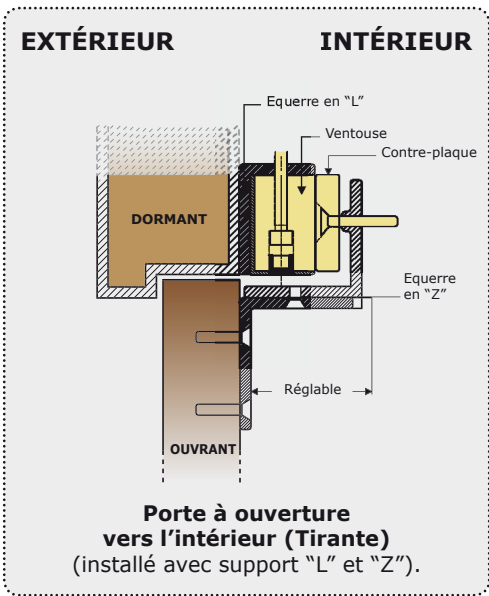
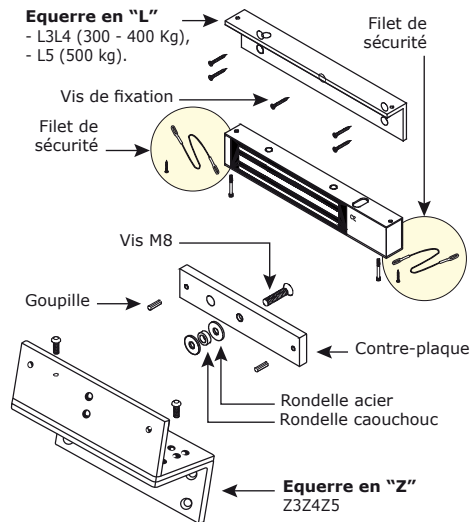

**7] MONTAGE AVEC ACCESSOIRES (EXEMPLE : GAMME V3S)**

**Montage avec support de contre-plaque**

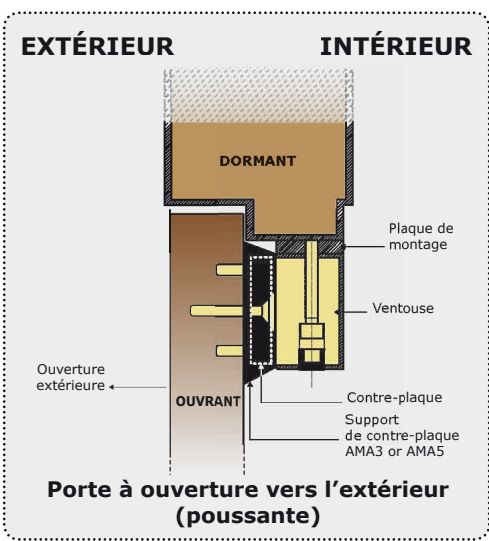
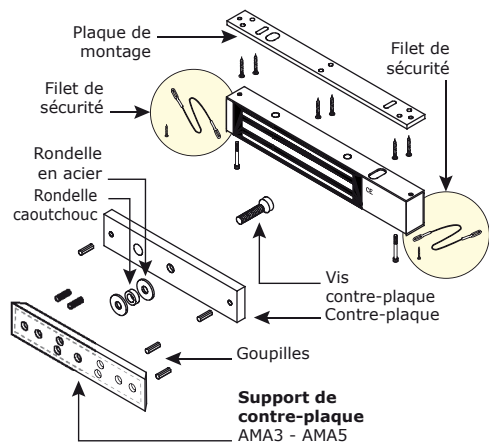



**V1SR - V3S - V3SR - V3SRB - V4S - V4SR - V4SRB - V5S - V5SR - V5SRB**  
*Ventouses électromagnétiques appliquées*

**Montage avec support pour porte en verre**

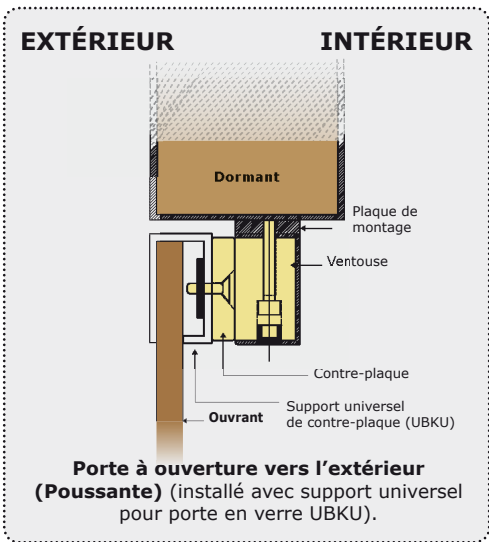
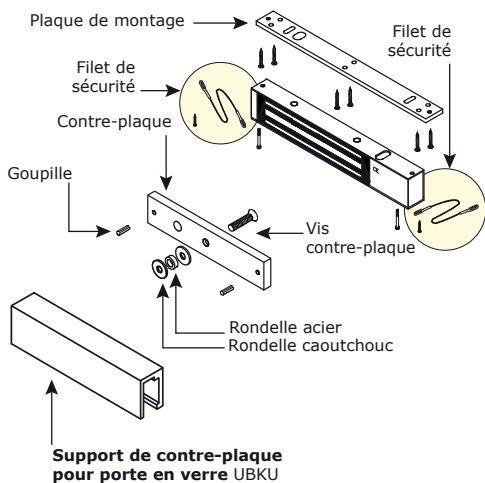

**Montage avec support pour porte en verre**

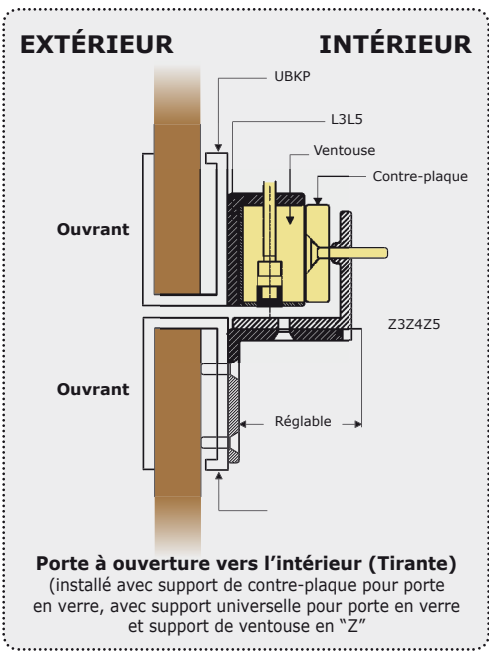
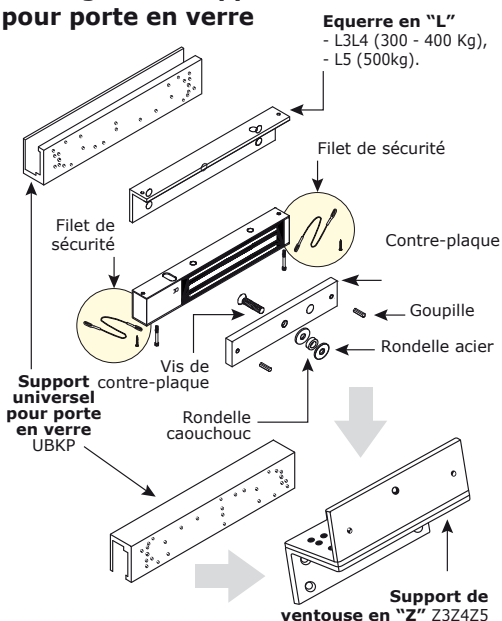

**V1SR - V3S - V3SR - V3SRB - V4S - V4SR - V4SRB - V5S - V5SR - V5SRB**  
*Ventouses électromagnétiques appliquées*

**Montage avec contact de position de porte (DPM300 - DPM400 - DPM500)\***

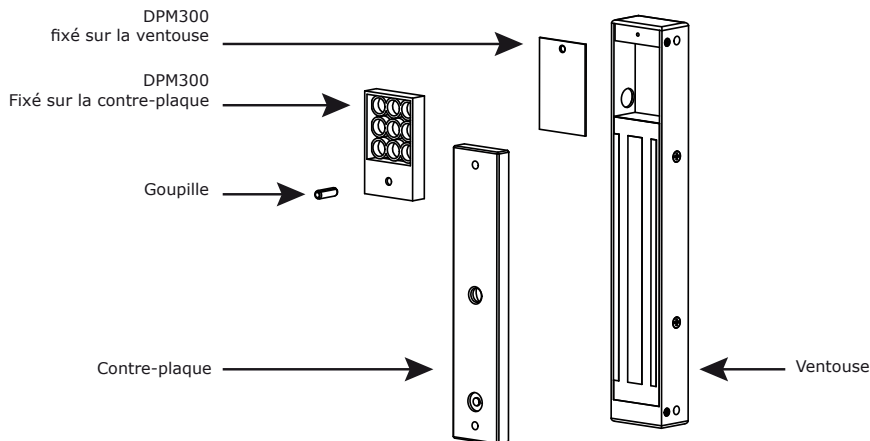

**8] DÉPANNAGE**

PROBLEMES	CAUSE POSSIBLE	SOLUTIONS
<b>Verrouillage de porte impossible</b>	La ventouse ne reçoit pas de courant continu.	<ul style="list-style-type: none"> <li>- Vérifier que les fils sont bien raccordés au bornier.</li> <li>- Vérifier que l'alimentation est compatible.</li> <li>- Vérifier que la ventouse est reliée correctement au circuit.</li> </ul>
<b>Force de maintien réduite</b>	La ventouse et la contre-plaque ne sont pas en vis à vis.	<ul style="list-style-type: none"> <li>- Vérifier que la ventouse est reliée correctement au circuit.</li> <li>- S'assurer que l'électroaimant et la contre-plaque sont bien en vis à vis.</li> <li>- Vérifier que les surfaces de contact sont exemptes de saletés et de rouille.</li> <li>- Vérifier que la contre-plaque est montée souple.</li> </ul>
	Tension basse, contre-plaque bridée.	S'assurer que la ventouse est bien alimentée par la tension requise, vérifier le serrage de la contre-plaque et l'état du caoutchouc.
<b>Commutateur Reed HS</b>	Tension trop basse. Mauvais alignement.	<ul style="list-style-type: none"> <li>- Vérifier l'alimentation.</li> <li>- Section de câble à déterminer selon la distance entre l'alimentation et le verrouillage.</li> <li>- ex: <math>2 \times 1,5\text{mm}^2 \geq 10\text{m}</math></li> </ul>

\* En option. Vendu séparément.





**CDVI Group**

FRANCE (Headquarter/Siège social)  
Phone: +33 (0)1 48 91 01 02  
Fax: +33 (0)1 48 91 21 21

**CDVI**

FRANCE + EXPORT  
Phone: +33 (0)1 48 91 01 02  
Fax: +33 (0)1 48 91 21 21

**CDVI AMERICAS**

[CANADA - USA]  
Phone: +1 (450) 682 7945  
Fax: +1 (450) 682 9590

**CDVI**

BENELUX  
[BELGIUM - NETHERLAND - LUXEMBOURG]  
Phone: +32 (0) 56 73 93 00  
Fax: +32 (0) 56 73 93 05

**CDVI**

TAIWAN  
Phone: +886 (0)42471 2188  
Fax: +886 (0)42471 2131

**CDVI**

SUISSE  
Phone: +41 (0)21 882 18 41  
Fax: +41 (0)21 882 18 42

**CDVI**

CHINA  
Phone: +86 (0)10 62414516  
Fax: +86 (0)10 62414519

**CDVI**

IBÉRICA  
[SPAIN - PORTUGAL]  
Phone: +34 (0)935 390 966  
Fax: +34 (0)935 390 970

**CDVI**

ITALIA  
Phone: +39 0331 97 38 08  
Fax: +39 0331 97 39 70

**CDVI**

MAROC  
Phone: +212 (0)5 22 48 09 40  
Fax: +212 (0)5 22 48 34 69

**CDVI**

SWEDEN  
[SWEDEN - DENMARK - NORWAY - FINLAND]  
Phone: +46 (0)31 760 19 30  
Fax: +46 (0)31 748 09 30

**CDVI**

UK  
[UNITED KINGDOM - IRELAND]  
Phone: +44 (0)1628 531300  
Fax: +44 (0)1628 531003

**CDVI DIGIT**

FRANCE  
Phone: +33 (0)1 41 71 06 85  
Fax: +33 (0)1 41 71 06 86

All the information contained within this document (pictures, drawing, features, specifications and dimensions) could be perceptibly different and can be changed without prior notice.  
Toutes les informations mentionnées à titre indicatif sur le présent document (photos, dessins, caractéristiques techniques et dimensions) peuvent varier et sont susceptibles de modifications sans notification préalable.