

Schraublage  
Schloss:

T-F1660 .../D 92/... M2

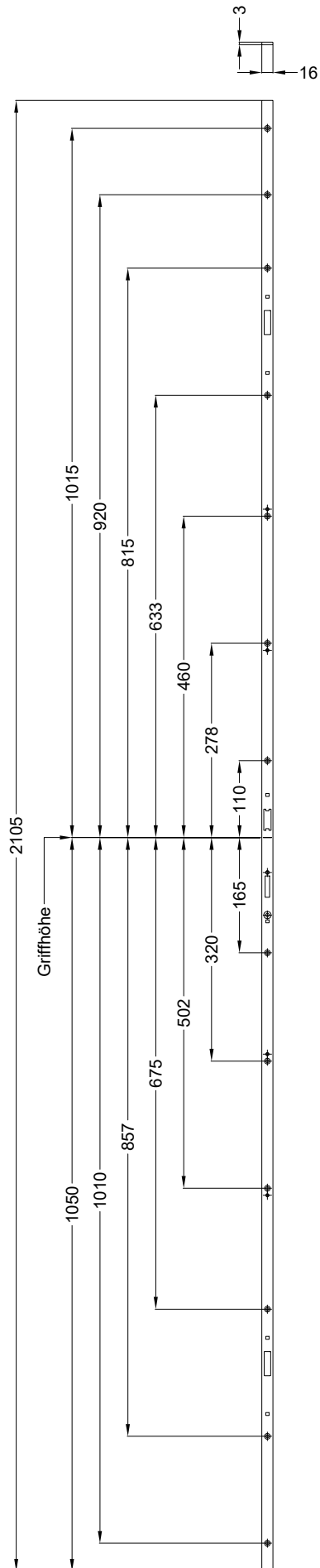

Technische Änderungen vorbehalten!



**Ansichten**  
**Schloss:**

**T-F1660 .../D 92/... M2**

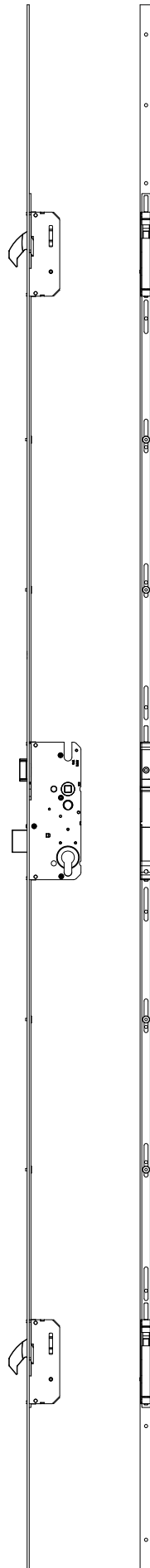

Technische Änderungen vorbehalten!

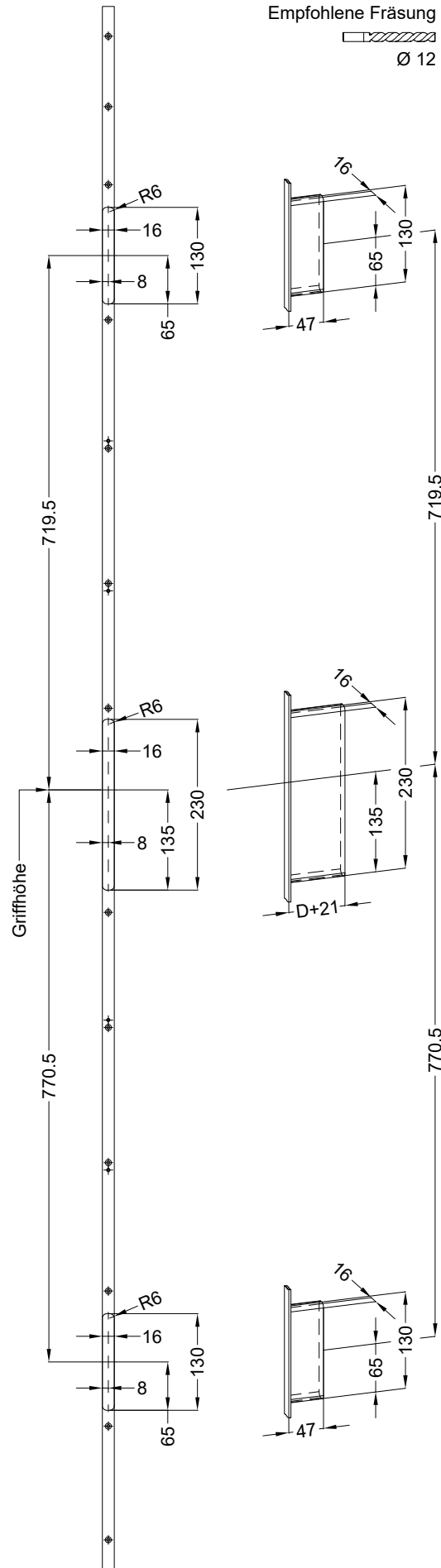

Allgemeine Vermaung

Frsmae

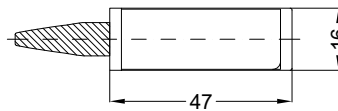
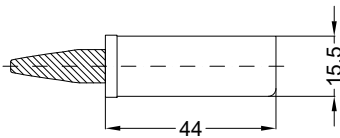

Situation  
Schwenkriegel

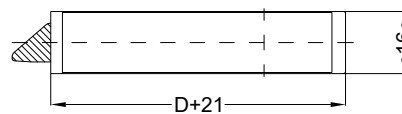
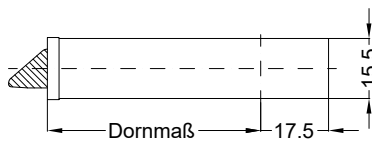

Situation  
Falle

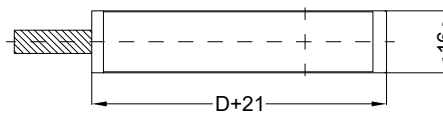
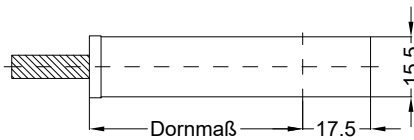

Situation  
Riegel

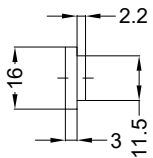

Lage  
Schloss

# Katalogdarstellung

Schloss: T-F1660 .../D 92/... M2



Technische Änderungen vorbehalten!

