



Barre



DOP N° : EN1125-01-A0



Barre coupe-feu



1 POINT

2/3 POINTS HAUT ET BAS

2/3 POINTS LATÉRAUX

Caractéristiques techniques

- Norme NF EN 1125:2008
- Résistance à la corrosion : 240 heures (Grade maximum prévu par la norme)
- Endurance > 200 000 ouvertures (Grade maximum prévu par la norme)
- Protection anti-bactérienne
- Barre de 1130 mm en standard largeur totale 1285 mm
- Profil étroit 37 mm permettant la pose sur tout type de support (bois, alu, acier, pvc)
- Projection de la barre 95 mm
- Cache-tringle
- Hauteur 2270 mm
- Fabriqué en Italie

Particularités :

- Pêne acier anti-intrusion limitant les risques d'intrusion de l'extérieur vers l'intérieur
- Forme très arrondie limitant tout risque de blessure et tout risque d'accrochage en cas de sortie précipitée
- Manivelles anti-pince doigt

Pose :

- Réversibilité sans aucun démontage
- Platine de pose atelier permettant le transport de la porte nue et le montage au dernier moment sur le chantier
- Accrochage des tringles par simple encliquetage sur le boîtier central et blocage sur les pènes haut et bas ou latéraux par vis pointeau avec une grande marge de réglage
- Pènes latéraux pour éliminer les problèmes de gâche au sol

Accessoires : (pages 70 à 74)

+ produits

- + PROTECTION ANTI-BACTÉRIENNE
- + Réversible sans démontage
- + Pènes anti-intrusion
- + Platine de pose atelier
- + Pose très rapide

GARANTIE 10 ANS⁽¹⁾

(1) selon CGV

Désignations	Gencod 8 02061	Références
1 POINT		
Barre CF, 1 point latéral, pêne acier, gris métal	425764 7	9411113774A
Barre CF, 1 point latéral, pêne acier, blanc	416310 8	9411113444A
Barre CF, 1 point latéral, pêne acier, noir	416309 2	9411113554A
2/3 POINTS HAUT ET BAS (Livrée avec obturateur)		
Barre CF, 2/3 points (1 latéral + haut et bas), pêne acier, gris métal	425772 2	9413113774A
Barre CF, 2/3 points (1 latéral + haut et bas), pêne acier, blanc	416283 5	9413113444A
Barre CF, 2/3 points (1 latéral + haut et bas), pêne acier, noir	416282 8	9413113554A
2/3 POINTS LATÉRAUX (Livrée avec obturateur)		
Barre CF, 2/3 points latéraux, pêne acier, gris métal	425781 4	9416113774A
Barre CF, 2/3 points latéraux, pêne acier, blanc	416974 2	9416113444A
Barre CF, 2/3 points latéraux, pêne acier, noir	416973 5	9416113554A

Gris : GRIS MÉTAL - Blanc : RAL 9016 - Noir : RAL 9005





DOP N° : EN1125-01-A0

Barre coupe-feu



1 POINT

2/3 POINTS HAUT ET BAS

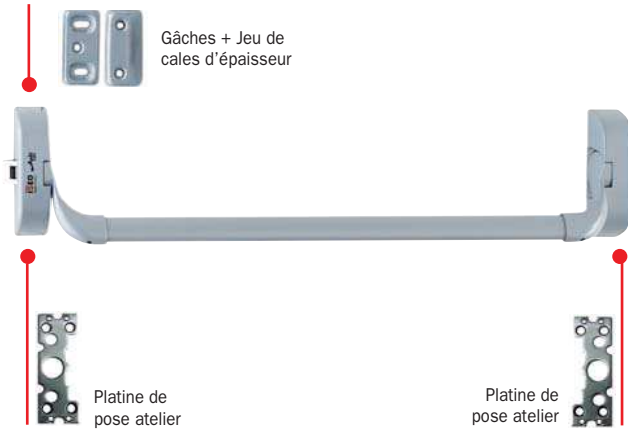

Dimensions

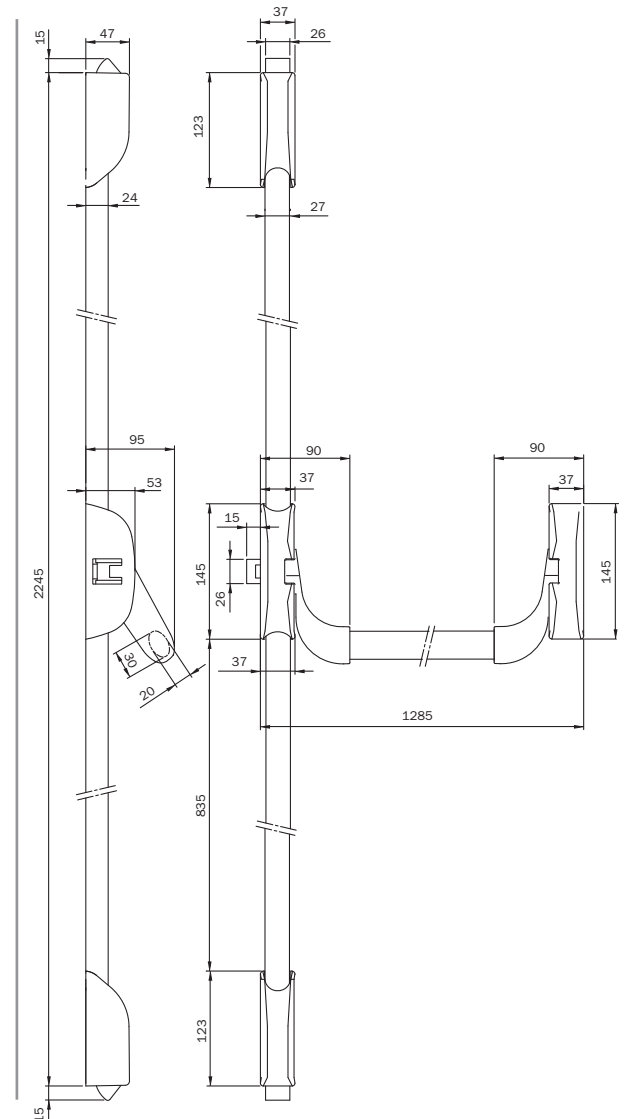
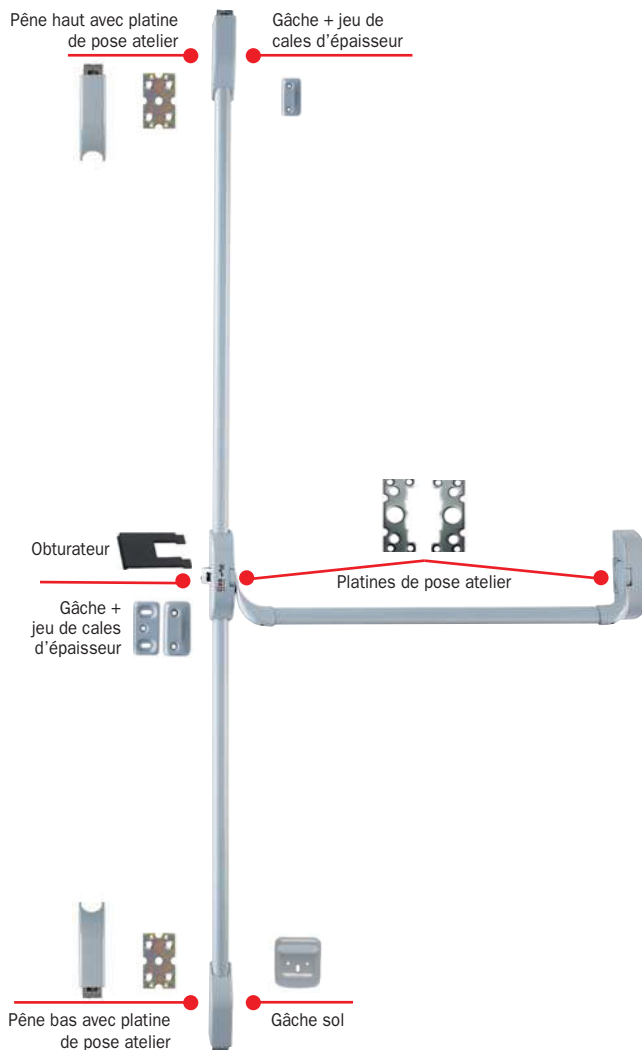
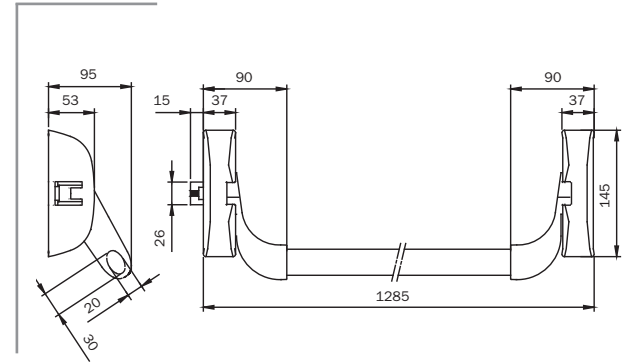



DOP N° : EN1125-01-A0

Barre coupe-feu



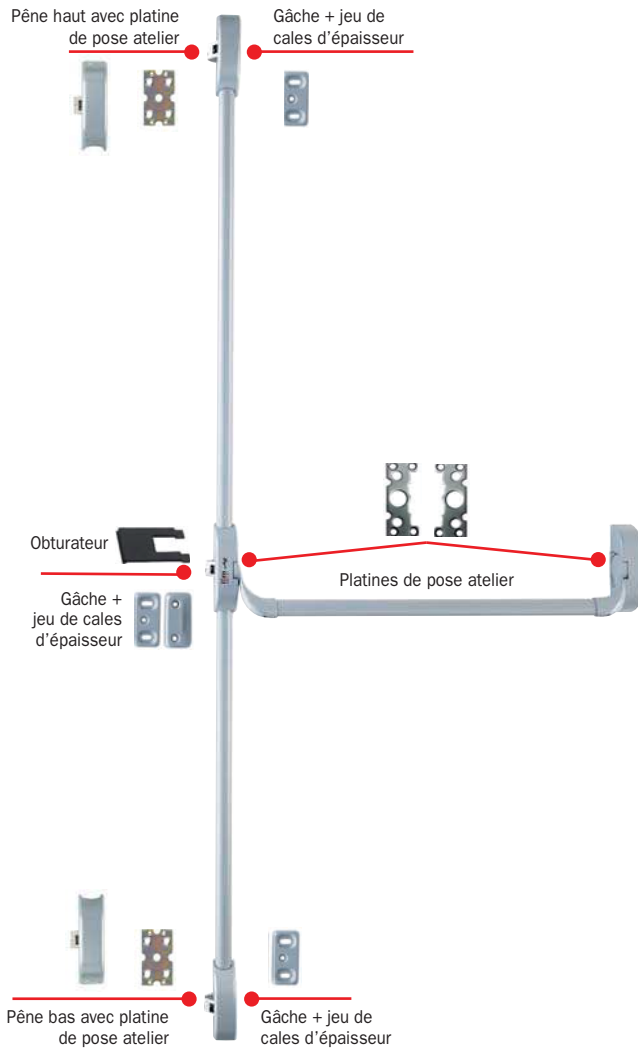



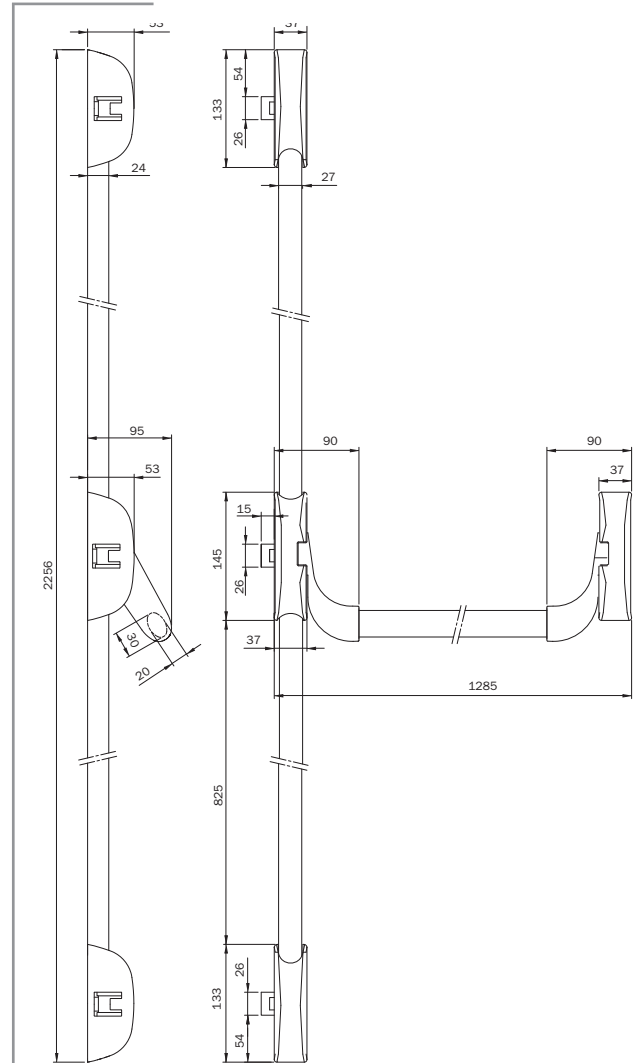



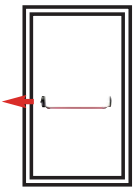
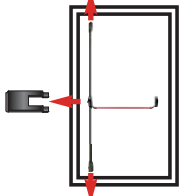
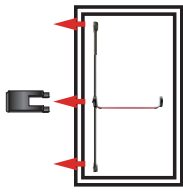





2/3 POINTS LATÉRAUX



Dimensions

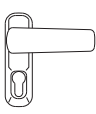

Barre coupe-feu : configuration pour porte 1 vantail

			
	9411113(xx)4A	9413113(xx)4A	9416113(xx)4A
<p>● INCLUS DANS LE CONDITIONNEMENT</p> <p>○ À COMMANDER SÉP.</p>			
<p>941(x)113(xx)4A </p>	●	●	●
<p>9410201(xx)5 (le jeu) </p>		●	
<p>9410003(x)04A </p>			
<p>9410203(x)05 (le jeu) </p>			●
<p>L = 2270 mm </p>		●	●
<p>Obturbateur </p>		●	●
<p>L = 1130 mm </p>	●	●	●
<p>94100040 </p>	● ●	● ●	● ●
<p>94100050 </p>		● ●	● ●
<p>9410012(x) </p>		●	
<p>9410010(x) </p>	●		● ● ●
<p>9410011(x) </p>	●	● ●	● ● ●
EN OPTION			
<p>9401100(x)T 9401200(x)T 9401300(x) 9401400(x) 9402100(x) </p>	○	○	○
<p>94091205E </p>			
<p>9410030(x) L = 3400 mm </p>		○	○
<p>94100060 </p>	○	○	○
<p>94100070 </p>	○	○	○

Le nombre de ● ○ correspond à la quantité de pièces contenues dans la référence (x) voir référence coloris

Barre coupe-feu : configuration pour porte 2 vantaux

	avec battent		avec battent		sans battent	
	9413113(xx)4A	9411113(xx)4A	9413113(xx)4A	9416113(xx)4A	9413113(xx)4A	9413113(xx)4A
● INCLUS DANS LE CONDITIONNEMENT ○ À COMMANDER SÉP.						
9411113(xx)4A	●	●	●	●	●	●
9410201(xx)4 (le jeu)	●		●		●	●
9410003(x)04A						
9410203(x)05 (le jeu)				●		
L = 2270 mm	●		●	●	●	●
Obturateur	●		●	●	●	●
L = 1130 mm	●	●	●	●	●	●
94100040	●●	●●	●●	●●	●●	●●
94100050	●●		●●	●●	●●	●●
94100(x)2(x)	●		●		●	●
9410010(x)		●		●●●		
9410011(x)	●●	●	●●	●●	●●	●●
EN OPTION						
9401100(x)T 9401200(x)T 9401300(x) 9401400(x) 9402100(x)		○		○		○
94091205E						
9410030(x) L = 3400 mm		○		○○		○○
94100060		○		○		○
94100070		○		○		○

Le nombre de ● ○ correspond à la quantité de pièces contenues dans la référence - (x) voir référence coloris

