

Perspektive
Schloss:

STV-U2460 .../D 92/... M2

WINK
HAUS

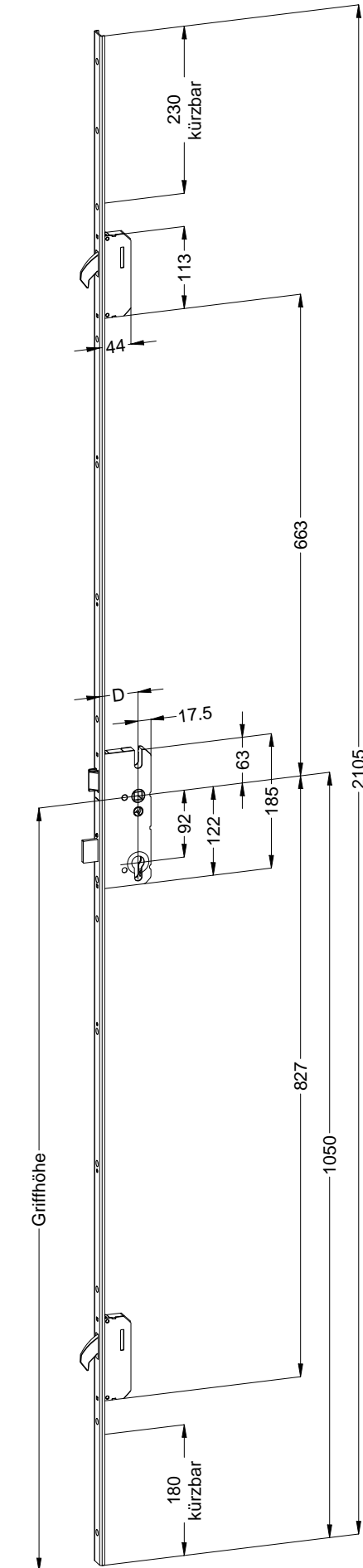

Technische Änderungen vorbehalten!

Schraublage
Schloss:

STV-U2460 .../D 92/... M2

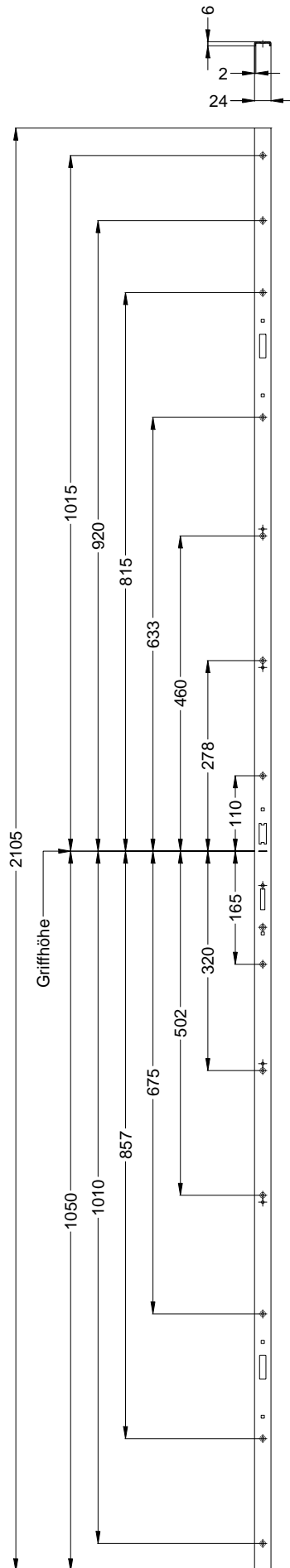

Technische Änderungen vorbehalten!

Ansichten
Schloss:

STV-U2460 .../D 92/... M2

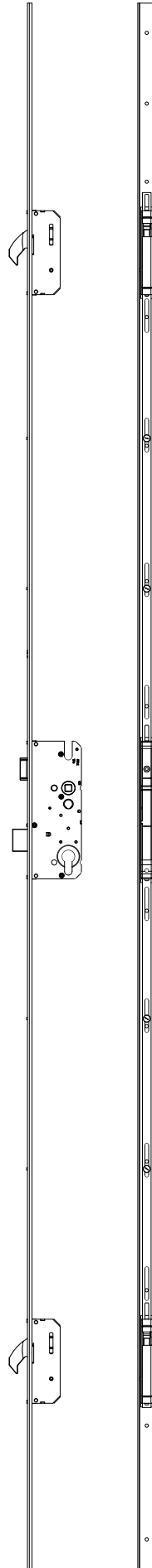

Technische Änderungen vorbehalten!

Allgemeine Vermaung

Frsmae

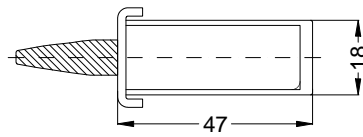
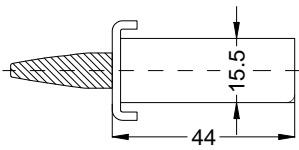

Situation
Schwenkriegel

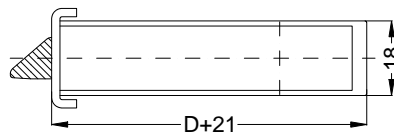
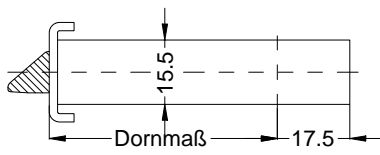

Situation
Falle

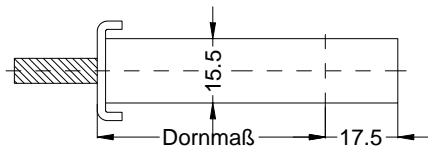

Situation
Riegel

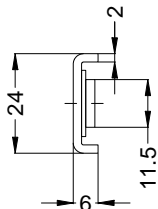

Lage
Schloss

