

Ansichten

Schloss: T-FG1674 .../D26-30 92/... A3

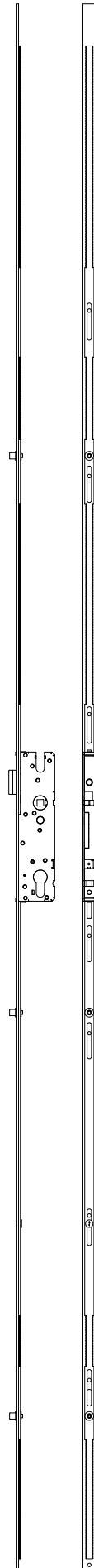

Technische Änderungen vorbehalten!

Fräsmaße

Schloss: T-FG1674 .../D26-30 92/... A3

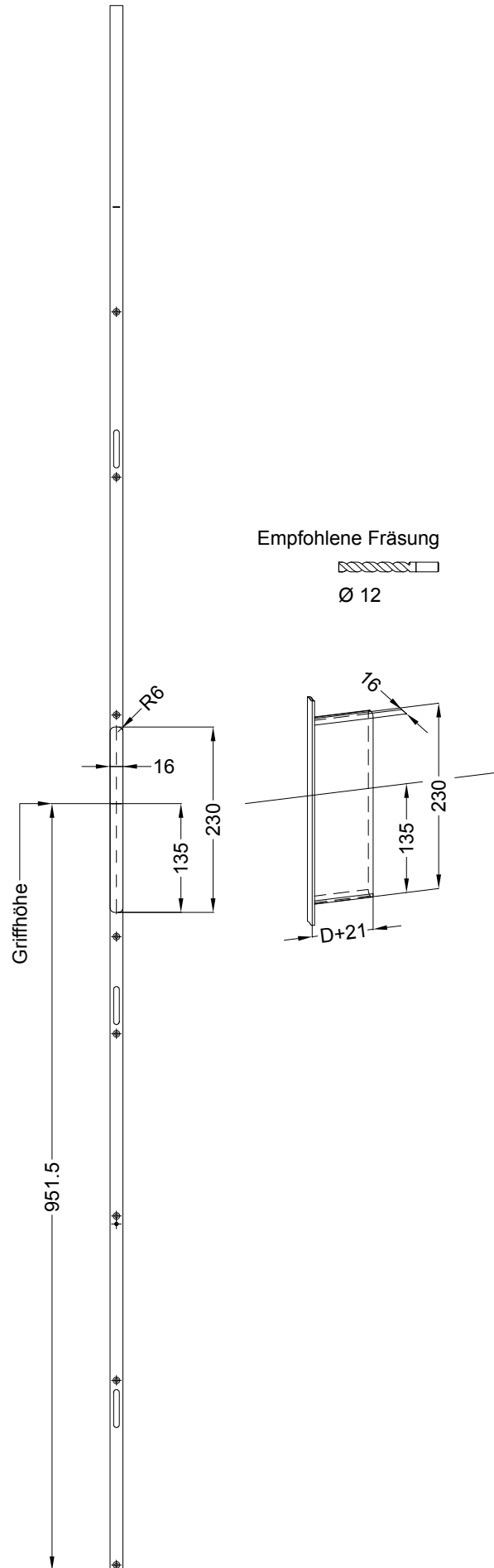

Technische Änderungen vorbehalten!

Allgemeine Vermaung

Frsmae

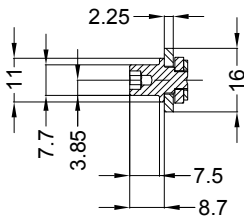

Situation
Schliessbolzen
ASS OF ACP V1

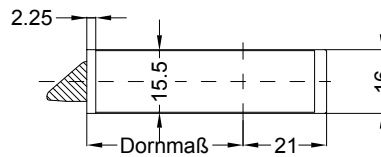
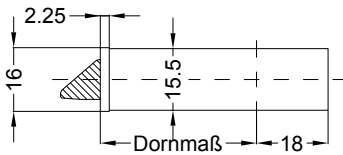

Situation
Falle

Technische Änderungen vorbehalten!

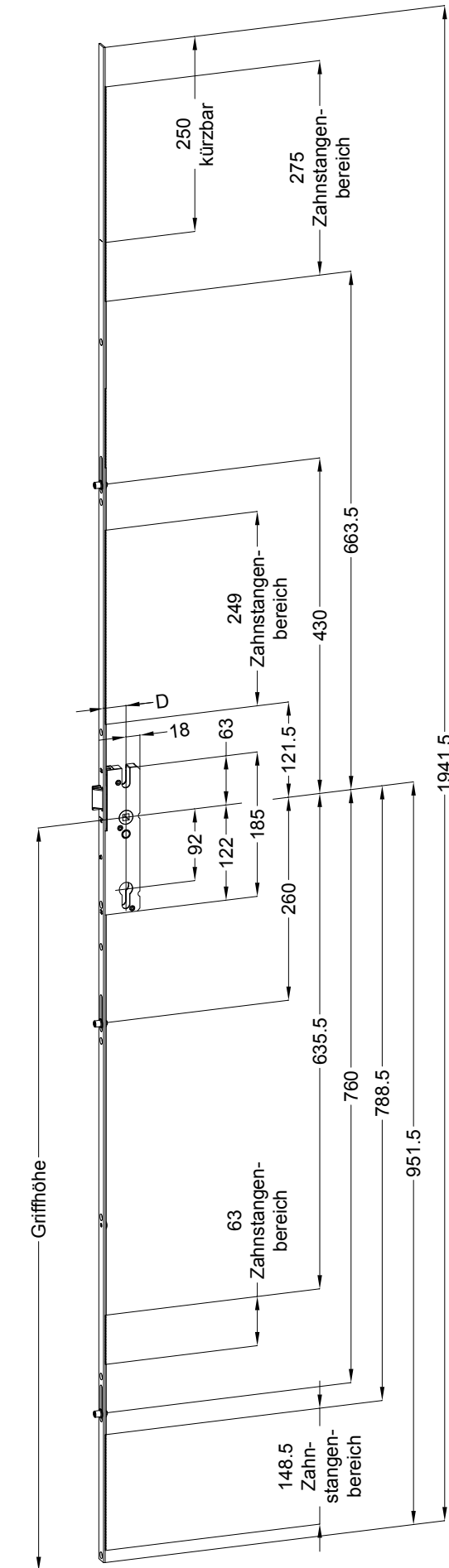

Empfohlene Fräsung

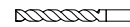

Ø 12

