

Perspektive
Schloss:

T-F1660 .../D 92/... M2

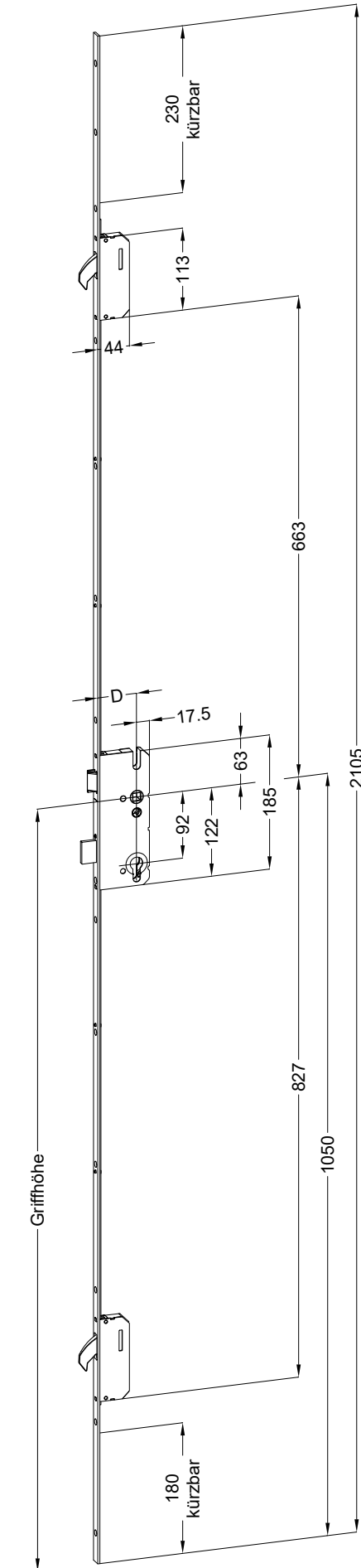

Technische Änderungen vorbehalten!

Schraublage
Schloss:

T-F1660 .../D 92/... M2



Technische Änderungen vorbehalten!

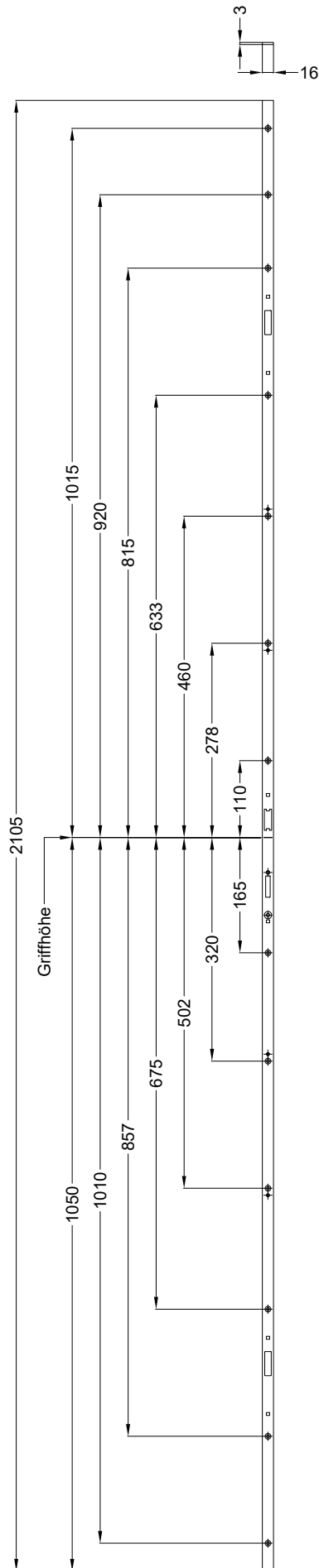

Ansichten
Schloss:

T-F1660 .../D 92/... M2

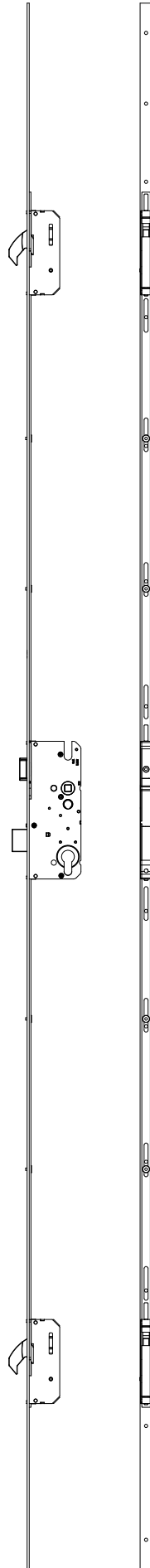

Technische Änderungen vorbehalten!

Allgemeine Vermaung

Frsmae

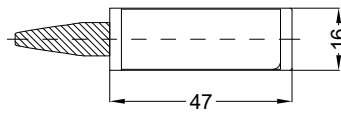
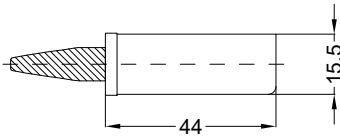

Situation
 Schwenkriegel

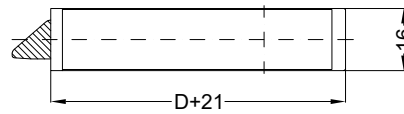
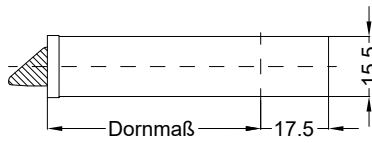

Situation
 Falle

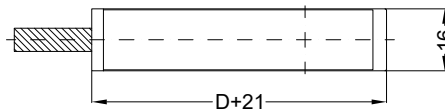
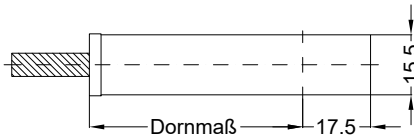

Situation
 Riegel

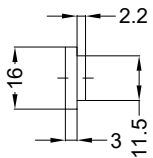

Lage
 Schloss

Katalogdarstellung

Schloss: T-F1660 .../D 92/... M2



Technische Änderungen vorbehalten!

