

Schraublage  
Schloss:

STV-F3060 P34 .../35 92/... M2

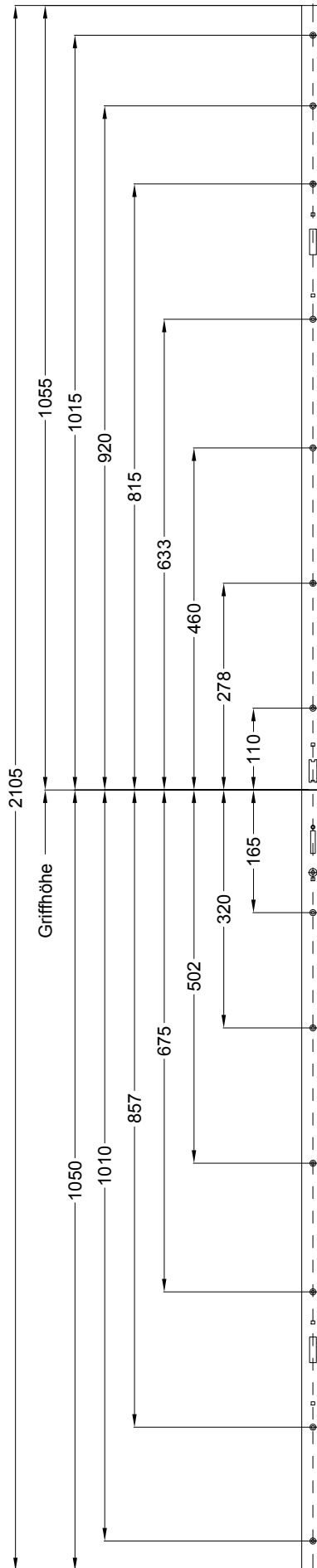

Technische Änderungen vorbehalten!

Ansichten  
Schloss:

STV-F3060 P34 .../35 92/... M2

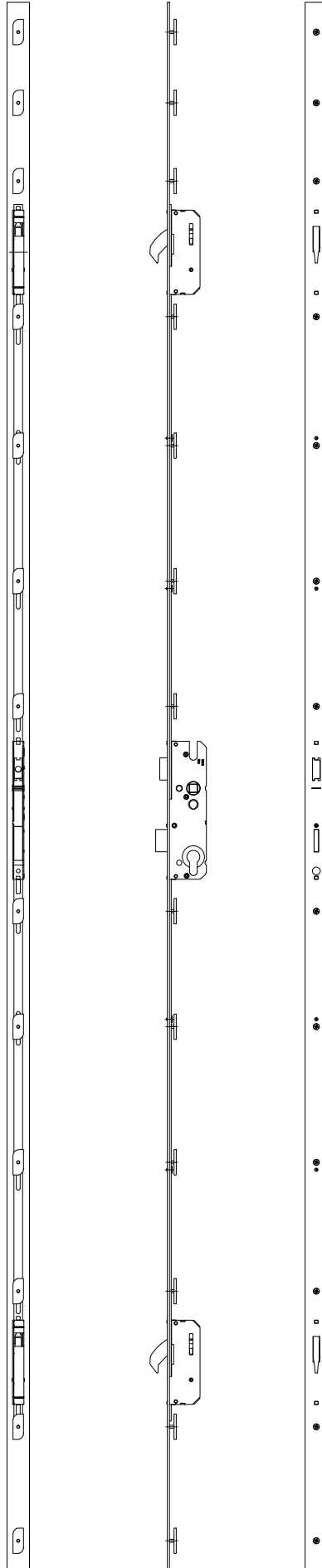

Technische Änderungen vorbehalten!

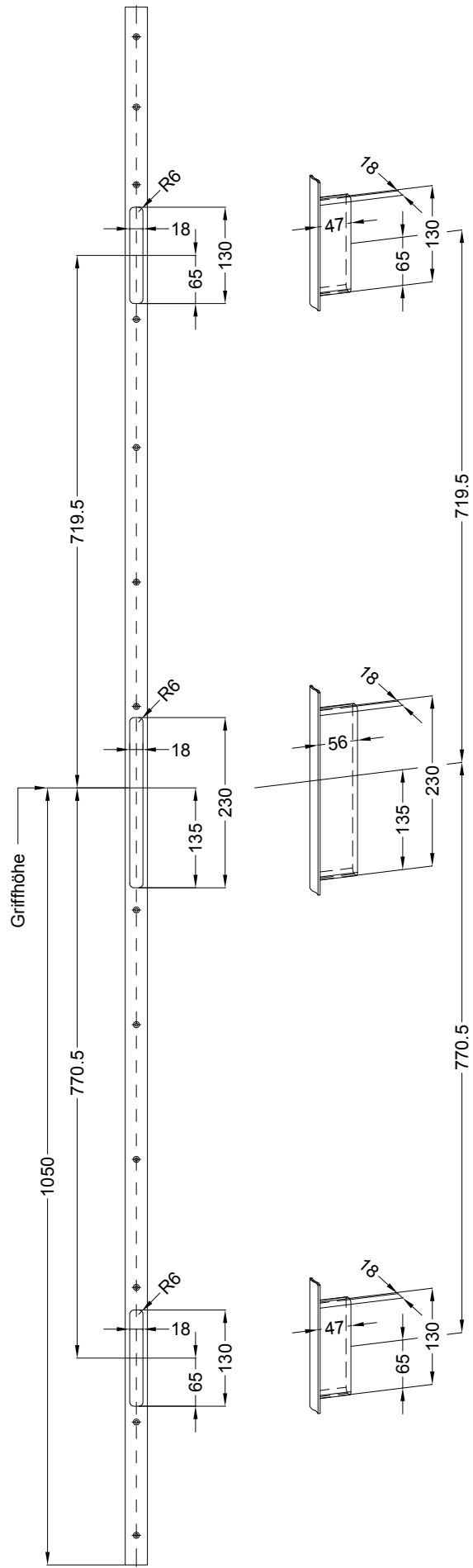

Technische Änderungen vorbehalten!

Allgemeine Vermaung

Frsmae

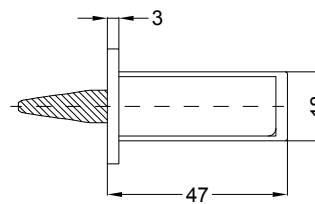
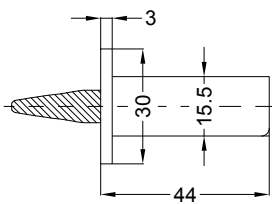

Situation  
 Schwenkriegel

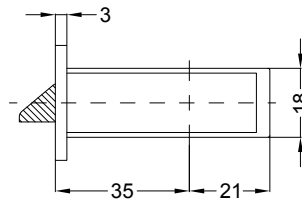
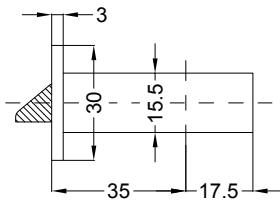

Situation  
 Falle

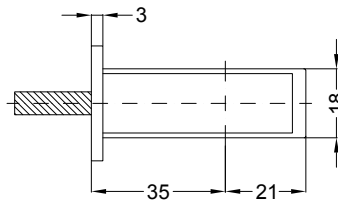
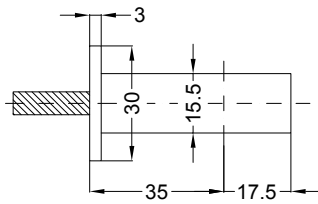

Situation  
 Riegel

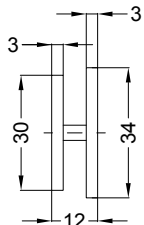

Lage Schloss  
 mit Klemmplatte

Technische Änderungen vorbehalten!

