

**Ansichten**  
**Schloss:**

**T-F2460 .../D 92/... M2**

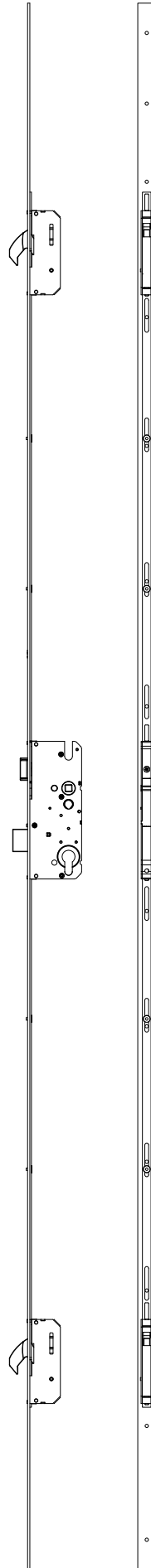

Technische Änderungen vorbehalten!

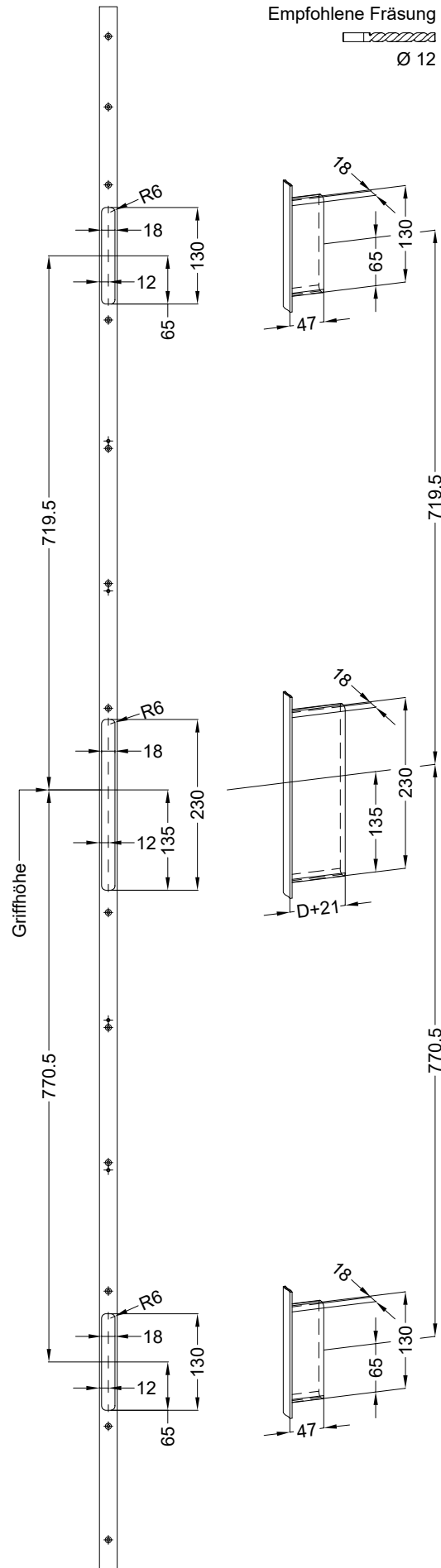

Einbausituationen der Bauteile mit Fräsmaßen  
 Schloss: T-F2460 .../D 92/... M2



Allgemeine Vermaßung

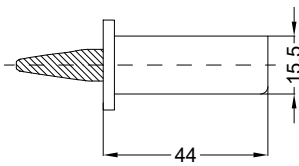

Fräsmaße

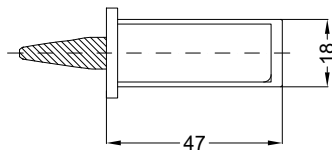

Situation  
 Schwenkriegel  
 Gehäuse TM6 Y2K BL

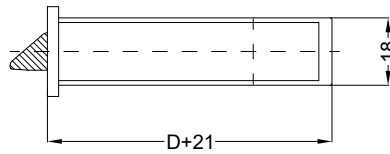
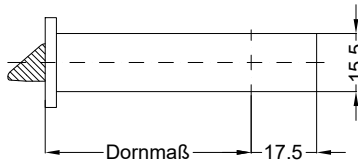

Situation  
 Falle  
 SK TP3

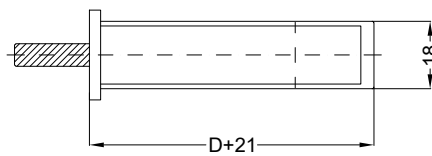
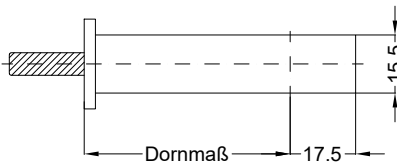

Situation  
 Riegel  
 SK TP3

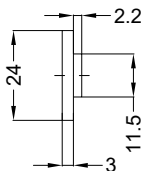

Lage  
 Schloss

Katalogdarstellung

Schloss: T-F2460 .../D 92/... M2



Technische Änderungen vorbehalten!

