

Perspektive
Schloss:

T-F1660 .../D 92/... M2

WINK
HAUS

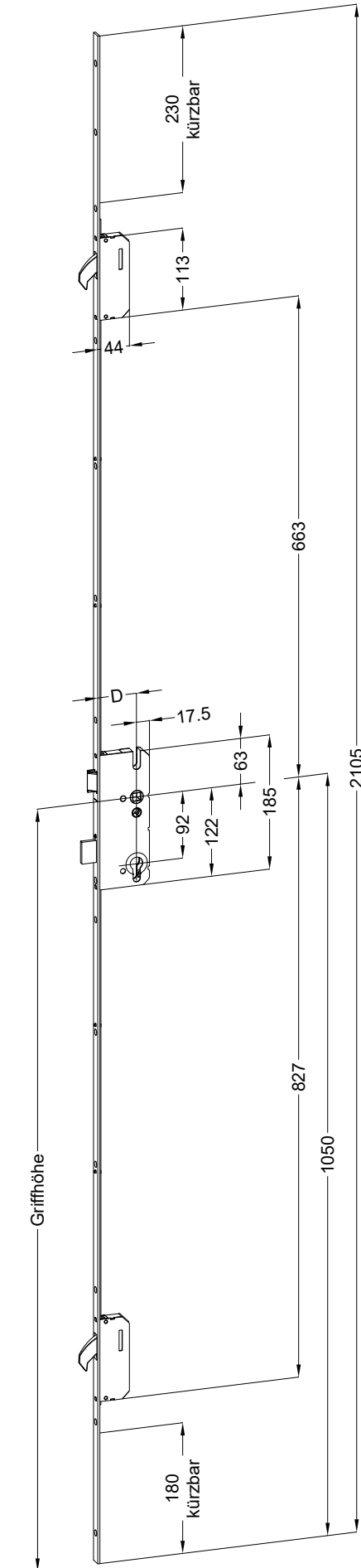

Technische Änderungen vorbehalten!

Schraublage
Schloss:

T-F1660 .../D 92/... M2



Technische Änderungen vorbehalten!

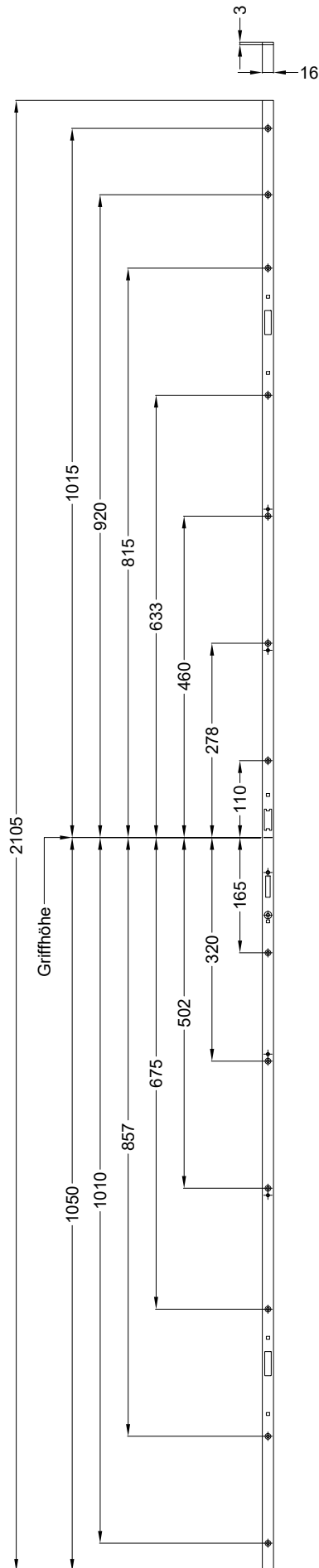

Ansichten
Schloss:

T-F1660 .../D 92/... M2

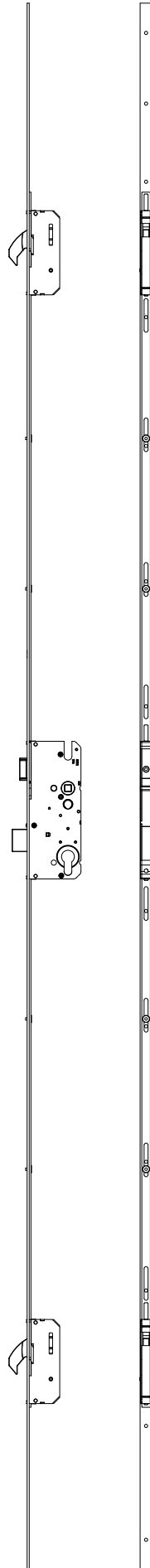

Technische Änderungen vorbehalten!

Einbausituationen der Bauteile mit Fräsmaßen

Schloss: T-F1660 .../D 92/... M2



Allgemeine Vermaung

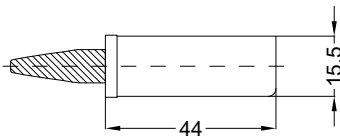

Frsmae

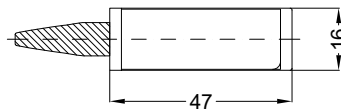

Situation
Schwenkriegel

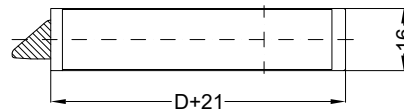
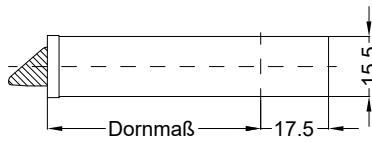

Situation
Falle

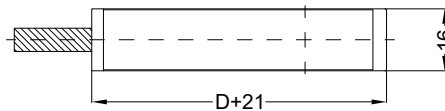
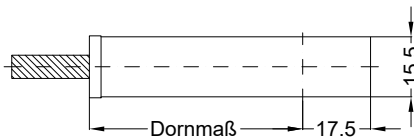

Situation
Riegel

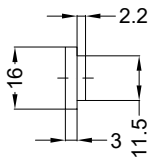

Lage
Schloss

