

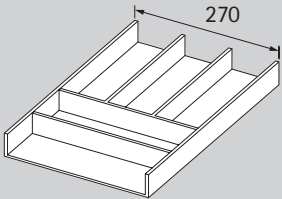

		AvanTech YOU / ArciTech		InnoTech / InnoTech Atira
		NL 450	NL 500	NL 470
A		9 278 291	9 278 292	9 287 303
B		9 278 293	9 278 294	9 278 304
C		C1 B = 105 mm 9 278 302	B = 118 mm 9 278 301	B = 115 mm 9 278 308
D		9 283 424	9 283 413	9 308 346
E		9 283 425	9 283 414	9 308 348
F		9 283 423	9 283 426	9 308 347
G		L = 100 mm B = 600 mm: 9 278 313 B = 1200 mm: 9 279 203	L = 89 mm B = 600 mm: 9 278 314 B = 1200 mm: 9 279 204	
H			9 278 309	
I			9 278 310	
J			9 278 312	

i

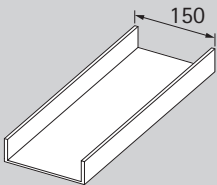
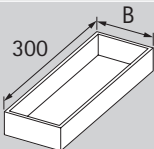
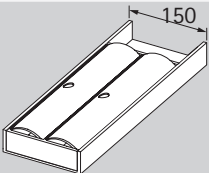
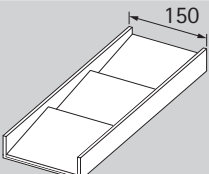
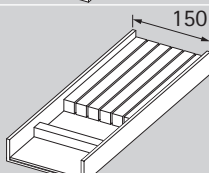
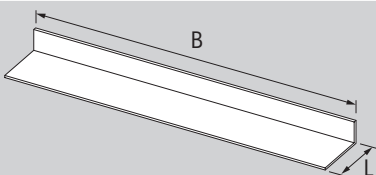
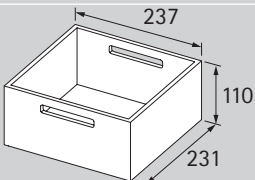
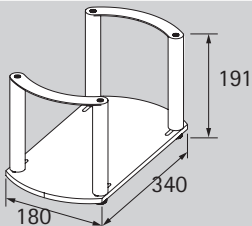

	B	T
AvanTech YOU	LB - 42	NL - 27
ArciTech	LB - 2 x EB - 62	NL - 27
InnoTech / InnoTech Atira	LB - 2 x EB - 59	NL - 8

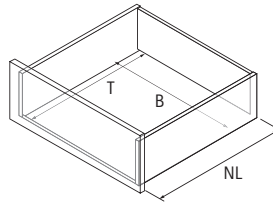
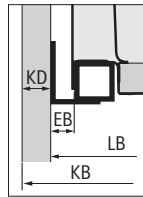
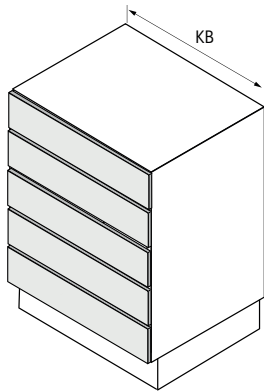
KB ≥ 300 AvanTech YOU
KB ≥ 350 ArciTech, InnoTech Atira

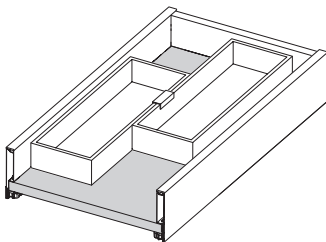

2 x **C1** + 1 x **J**

KD ≤ 19 mm

KB ≥ 350 AvanTech YOU
KB ≥ 400 ArciTech, InnoTech Atira

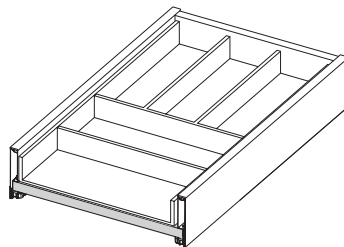

1 x **A**

KD ≤ 19 mm

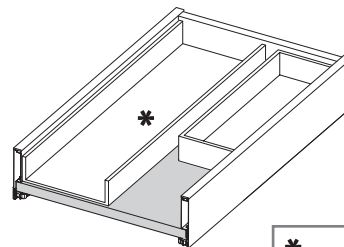

1 x **B** + 1 x **C**

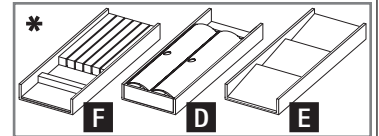

KB ≥ 400 AvanTech YOU
KB ≥ 450 ArciTech, InnoTech Atira

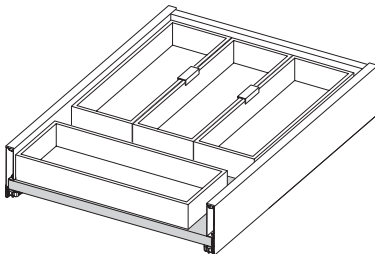

3 x **C1** + 1 x **C** + 2 x **J**

KD ≤ 19 mm

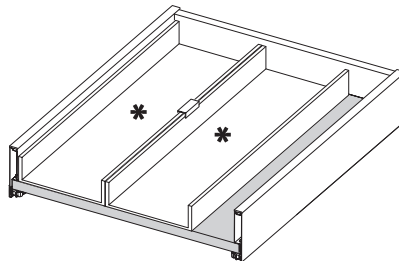

2 x **B** + 1 x **J**

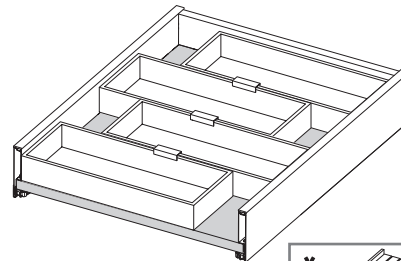

4 x **C** + 3 x **J**

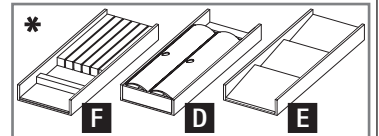

KB ≥ 450 AvanTech YOU
KB ≥ 500 ArciTech, InnoTech Atira

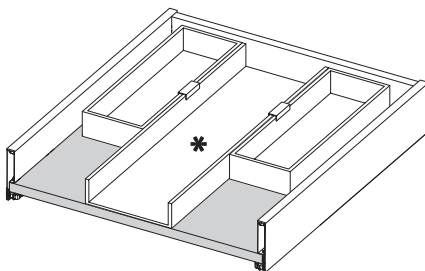

1 x **B** + 2 x **C1** + 2 x **J**

KD ≤ 19 mm

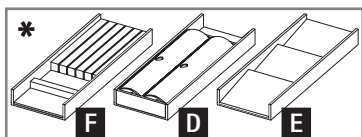

KB ≥ 500 AvanTech YOU
KB ≥ 550 ArciTech, InnoTech Atira

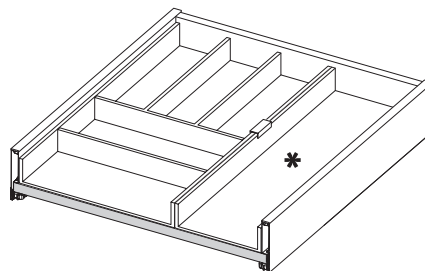

1 x **A** + 1 x **B** + 1 x **J**

KD ≤ 19 mm

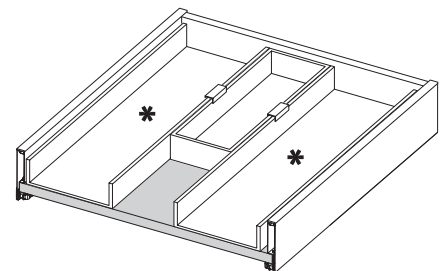

2 x **B** + 1 x **C** + 2 x **J**

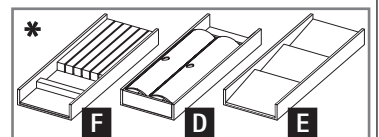

KB ≥ 550 AvanTech YOU
KB ≥ 600 ArciTech, InnoTech Atira

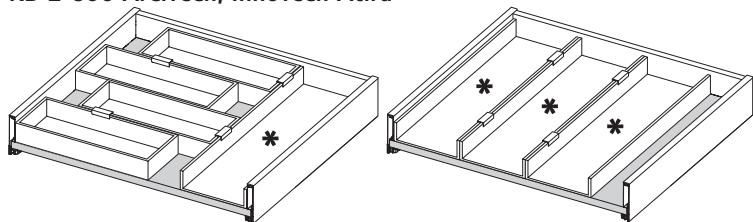

1 x **B** + 4 x **C** + 2 x **J**

3 x **B** + 4 x **J**

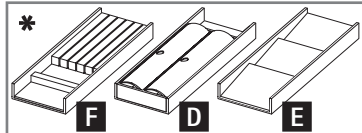

KD ≤ 19 mm

KB ≥ 600 AvanTech YOU
KB ≥ 650 ArciTech, InnoTech Atira

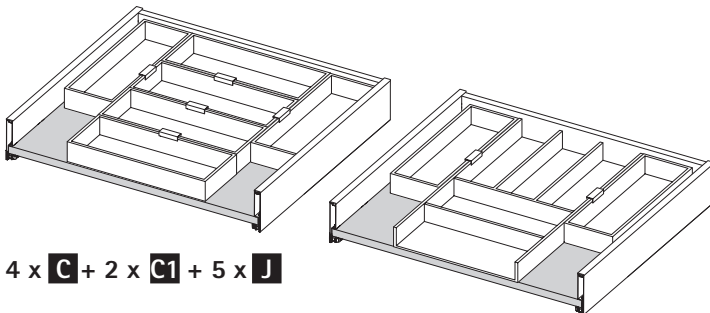

4 x **C** + 2 x **C1** + 5 x **J**

1 x **A** + 2 x **C** + 2 x **J**

KD ≤ 19 mm

KB ≥ 650 AvanTech YOU
KB ≥ 700 ArciTech, InnoTech Atira

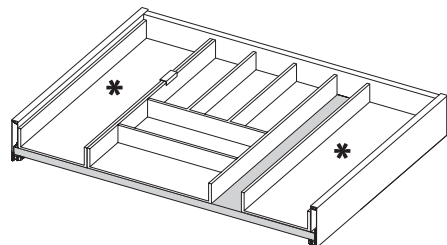

1 x **A** + 2 x **B** + 1 x **J**

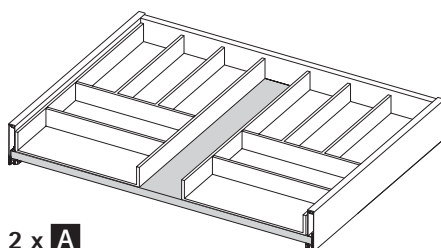

2 x **A**

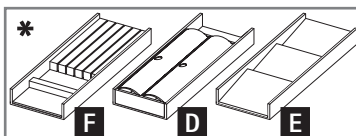

KD ≤ 19 mm

KB ≥ 750 AvanTech YOU
KB ≥ 800 ArciTech, InnoTech Atira

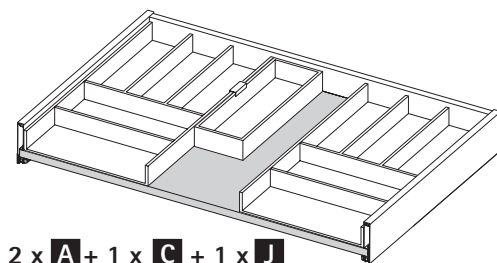

2 x **A** + 1 x **C** + 1 x **J**

KD ≤ 19 mm

KB ≥ 800 AvanTech YOU
KB ≥ 850 ArciTech, InnoTech Atira

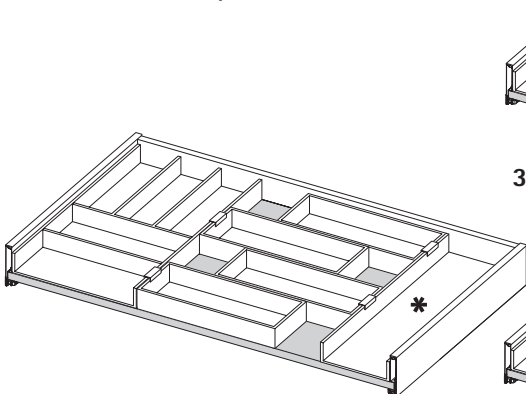

1 x **A** + 4 x **C** + 1 x **B** + 4 x **J**

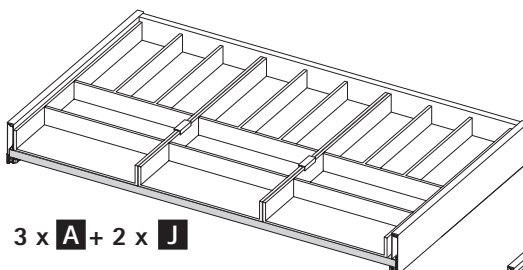

3 x **A** + 2 x **J**

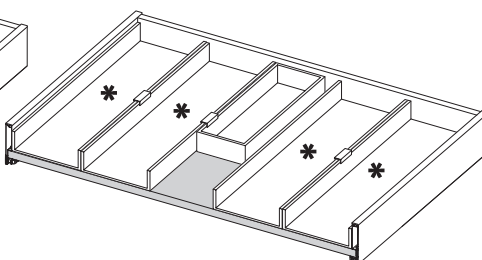

4 x **B** + 1 x **C** + 3 x **J**

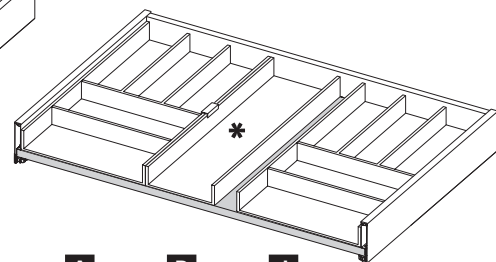

2 x **A** + 1 x **B** + 1 x **J**

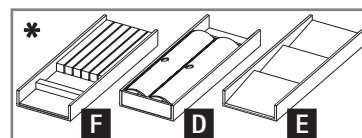

KD ≤ 19 mm

KB ≥ 900 AvanTech YOU
KB ≥ 950 ArciTech, InnoTech Atira

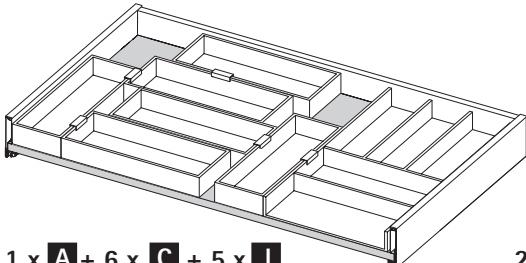

1 x **A** + 6 x **C** + 5 x **J**

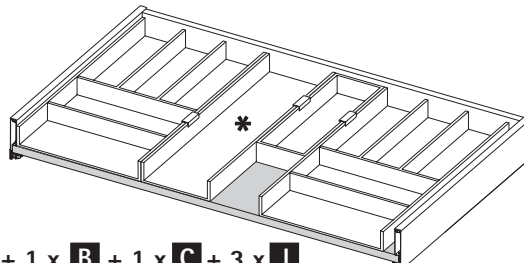

2 x **A** + 1 x **B** + 1 x **C** + 3 x **J**

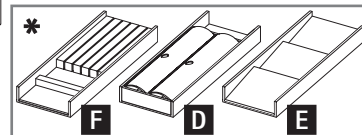

KD ≤ 19 mm

KB ≥ 950 AvanTech YOU
KB ≥ 1000 ArciTech, InnoTech Atira

KD ≤ 19 mm

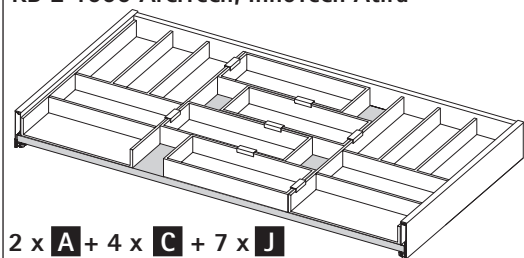

2 x **A** + 4 x **C** + 7 x **J**

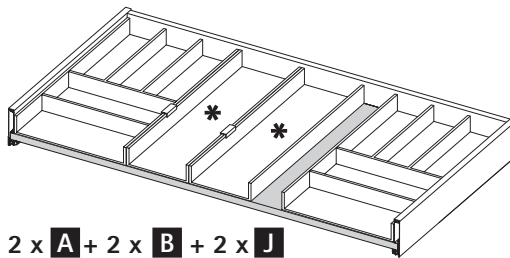

2 x **A** + 2 x **B** + 2 x **J**

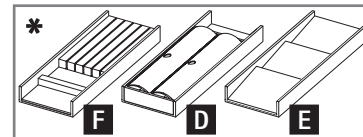

KB ≥ 1000 AvanTech YOU
KB ≥ 1050 ArciTech, InnoTech Atira

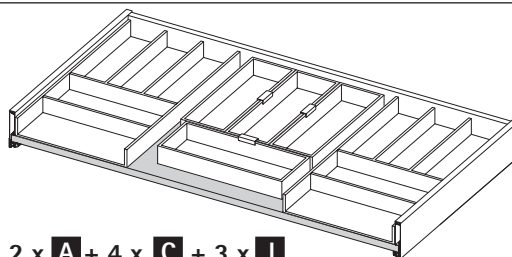

2 x **A** + 4 x **C** + 3 x **J**

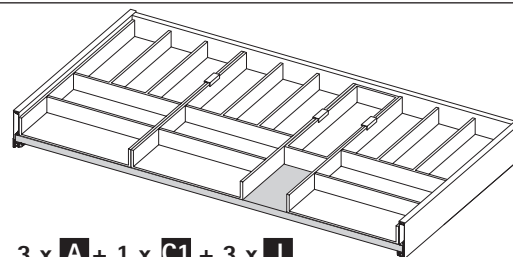

3 x **A** + 1 x **C1** + 3 x **J**

KD ≤ 19 mm

KB ≥ 1150 AvanTech YOU
KB ≥ 1200 ArciTech, InnoTech Atira

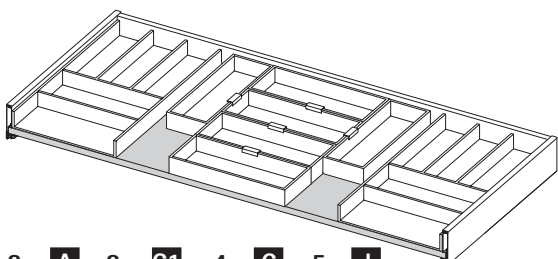

2 x **A** + 2 x **C1** + 4 x **C** + 5 x **J**

KD ≤ 19 mm

KB ≥ 1200 AvanTech YOU

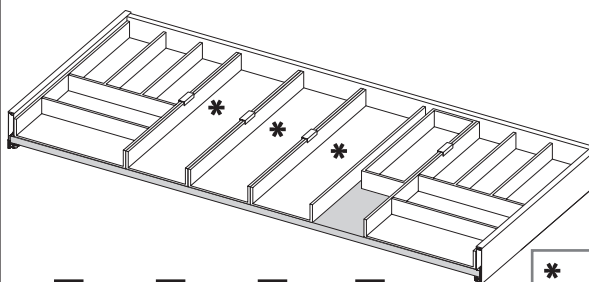

2 x **A** + 3 x **B** + 1 x **C** + 4 x **J**

KD ≤ 19 mm

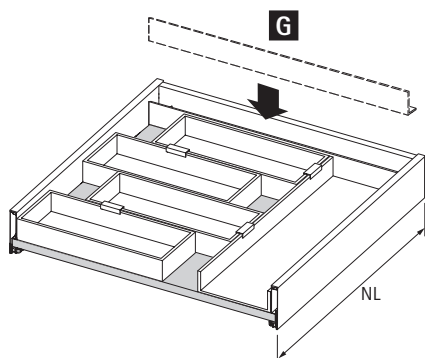
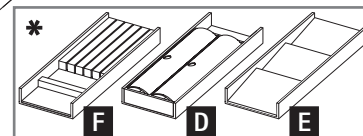

AvanTech YOU, ArciTech	NL		 L = 100 mm B = 600 mm: 9 278 313 B = 1200 mm: 9 279 203
	450	A-F , NL 450	
	500	A-F , NL 500	
	550	A-F , NL 450	+ 1x G L = 100 mm
	600	A-F , NL 500	+ 1x G L = 100 mm
	650	A-F , NL 450	+ 2x G L = 100 mm
InnoTech Atira	NL		 L = 89 mm B = 600 mm: 9 278 314 B = 1200 mm: 9 279 204 L = 100 mm B = 600 mm: 9 278 313 B = 1200 mm: 9 279 203
	470	A-F , NL 470	
	520	A-F , NL 450	+ 1x G L = 89 mm
	620	A-F , NL 450	+ 1x G L = 89 mm + 1x G L = 100mm

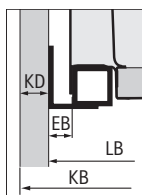
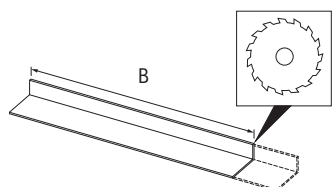

AvanTech YOU	B = LB - 42
ArciTech	B = LB - 2 x EB - 62
InnoTech Atira	B = LB - 2 x EB - 59