



GP - X



SP - X



SP - HX



PR - X



SP - RX



SP - UX



### CARACTÉRISTIQUES

- Gamme de profilés galvanisés indextrut pour charges lourdes de tuyauteries pour fluides.
- Ils offrent une grande versatilité pour leur mise en œuvre : suspendus, fixés directement au mur, fixés à d'autres supports perforés, etc.
- Ils sont compatibles avec toute la gamme de colliers du catalogue, pouvant s'utiliser aussi bien avec les colliers pour tuyauteries qu'avec les colliers pour câblage électrique.
- Idéal pour les spécialistes de ce type d'installation.

### MATÉRIAU DE BASE



## EXEMPLES D'APPLICATION





















Rails et console rails pour installations électriques, télécommunications et tuyauteries.

Supports pour chemin de câbles

Accessoires en complément des équipements basiques.

# 1. GAMME

ITEM	PHOTO	RÉFÉRENCE	DESCRIPTION	MATERIEL	REVÊTEMENT
1		GPX412115	Rail 41 x 21 x 1.50	 Acier	 Pré-Galvanisé ≥ 19µm
		GPX412120	Rail 41 x 21 x 2.00		
		GPX412125	Rail 41 x 21 x 2.50		
		GPX414115	Rail 41 x 41 x 1.50		
		GPX414120	Rail 41 x 41 x 2.00		
		GPX414125	Rail 41 x 41 x 2.50		
		GPX2M412120	Rail 41 x 21 x 2.00		
		GPX2M414120	Rail 41 x 41 x 2.00		
2		SPX412115	Console rail 41 x 21 x 2.50 x 150	 Acier	 Zingué ≥ 5µm
		SPX412130	Console rail 41 x 21 x 2.50 x 300		
		SPX412145	Console rail 41 x 21 x 2.50 x 450		
		SPX414115	Console rail 41 x 41 x 2.50 x 150		
		SPX414130	Console rail 41 x 41 x 2.50 x 300		
		SPX414145	Console rail 41 x 41 x 2.50 x 450		
		SPX414160	Console rail 41 x 41 x 2.50 x 600		
		SPX414175	Console rail 41 x 41 x 2.50 x 750		
SPX414110	Console rail 41 x 41 x 2.50 x 1000				
3		SPGH3840	Support horizontal	 Acier	 Zingué ≥ 5µm
4		PRX01	Support réglable pour rails Indextrut	 Acier	 Zingué ≥ 5µm
5		SPRXH4121	Support-base rectangulaire en "U" Indextrut	 Acier	 Zingué ≥ 5µm
		SPRXV4121			
6		SPUX412100	Platine de base en "U" Indextrut	 Acier	 Zingué ≥ 5µm
		SPUX412145			



### 3. DONNÉES D'INSTALLATION

#### 3.1 GP-X

#### Rail perforé Indextrut



Matériel



Acier

Revêtement



Revêtement Pré-Galvanisé  $\geq 19\mu\text{m}$

#### Données d'installation

Code	A1	A2	B	C	$\varnothing D$	E	F	G	H	L1	L2	L3									
GPX412115	41	21	1,5	7	14	22,3	10	30	50	3000	100	20									
GPX412120			2,0																		
GPX412125			2,5																		
GPX414115		41	41							1,5											
GPX414120										2,0											
GPX414125										2,5											
GPX2M412120			21							2,0									2000		
GPX2M414120			41							2,0											

#### Plan

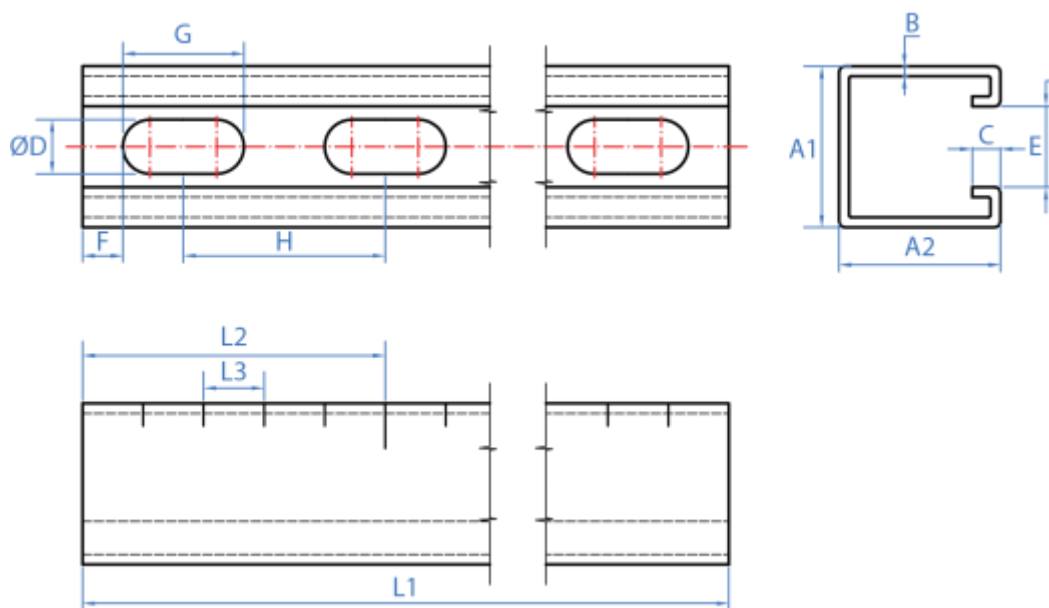

### 3.2 SP-X

### Console rail perforé Indextrut



Matériel	Revêtement
Acier	Zingué

#### Données d'installation

Code	A1	A2	B1	B2	C	ØD	Ød1	Ød2	E	F	G1	G2	H	L1	L2	L3
SPX412115		21												150	70	110
SPX412130														300		
SPX412145														450		
SPX414115	41	41	2,5	5	7	14	13	10	22,3	10	30	22	50	150	90	132
SPX414130														300		
SPX414145														450		
SPX414160														600		
SPX414175														750		
SPX414110														1000		

#### Plan

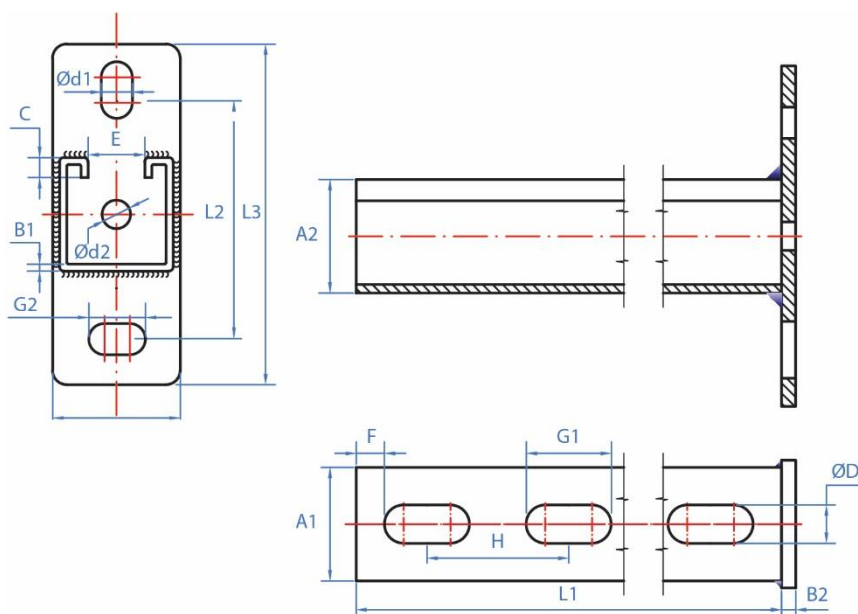

### 3.3 SP-HX

#### Support perforé horizontal pour rail Indextrut



Matériel	Revêtement	Valable pour
Acier	Zingué	Rail perforé indextrut

#### Données d'installation

Code	A1	A2	B1	B2	C	ØD	Ød	E	G1	G2	L1	L2	L3
SPGH3840	42	35	4	6	60	13,5	11	12	25	16	90	103	145

#### Plan

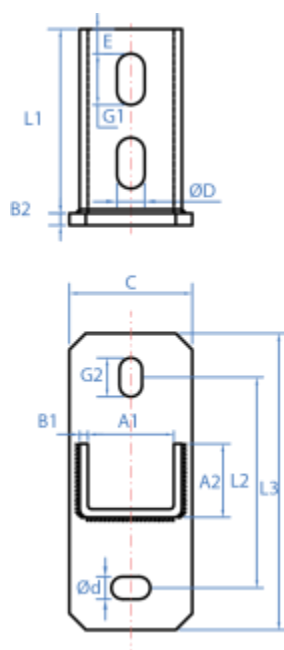

### 3.4 PR-X

### Support réglable pour rails Indextrut



Matériel	Revêtement	Valable pour
Acier	Zingué	Rail perforé indextrut

#### Données d'installation

Code	A	B	SW	Charge maximale recommandée [kg]
PRX01	56	152,5	17	560

#### Plan

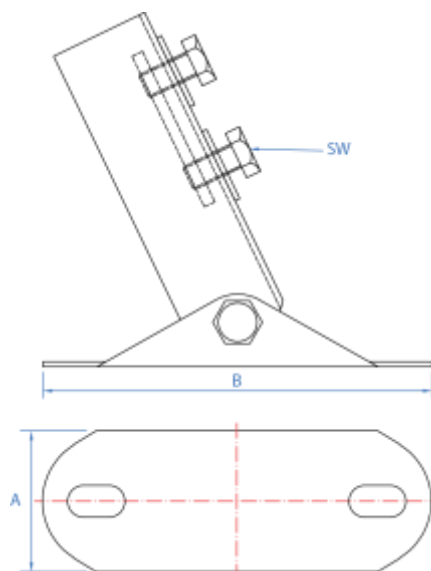



### 3.5 SP-RX

### Support-base rectangulaire en "U" Indextrut



Matériel	Revêtement	Valable pour
Acier	Zingué	Rail perforé indextrut

#### Données d'installation

Code	L1	A	B	C	ØD	E	F	G	H
SPRXH4121	150	70	5	90	14	48	21	22,5	105
SPRXV4121	70	150	5	90	14	48	21	22,5	105

#### Plan

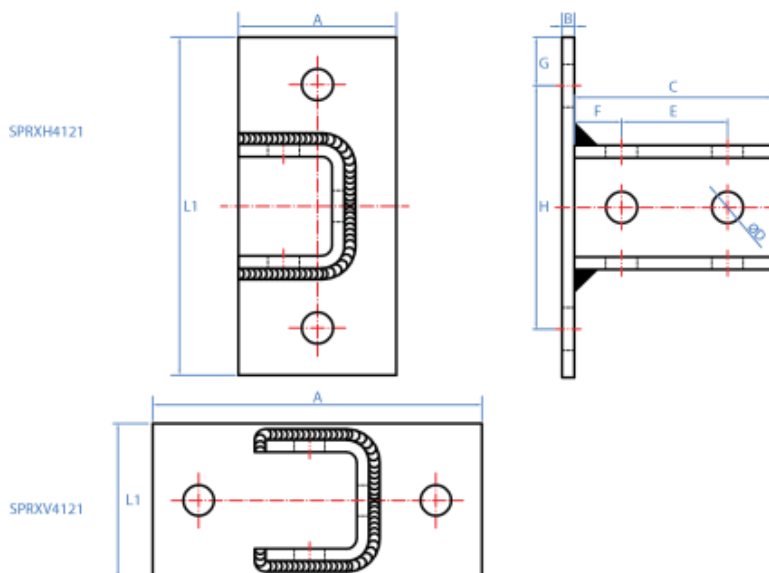

### 3.6 SP-UX

#### Platine de base en "U" Indextrut



Matériel	Revêtement	Valable pour
Acier	Zingué	Rail perforé indextrut

#### Données d'installation

Code	A	B	C	ØD	E	F	G	H
SPUX412100	150	5	90	14	48	21	22,5	105
SPUX412145	150	5	90	14	48	21	22,5	105

#### Plan

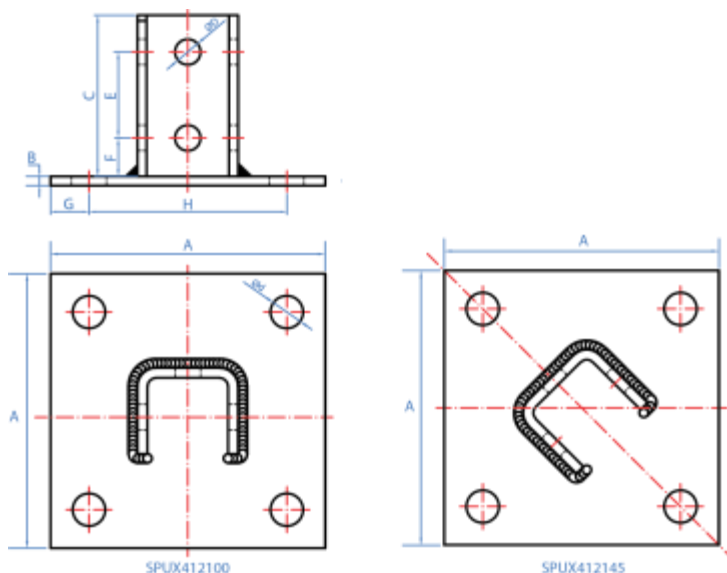

## 4. DONNÉES GÉOMÉTRIQUES

REFERENCE	SECTION	POIDS	AIRE	MOMENT D'INERTIE I <sub>y</sub>	MOMENT D'INERTIE I <sub>z</sub>	MODULE DE RÉSISTANCE (W <sub>y</sub> )	MODULE DE RÉSISTANCE (W <sub>z</sub> )
	[mm x mm]	[Kg/m]	[cm <sup>2</sup> ]	[cm <sup>4</sup> ]	[cm <sup>4</sup> ]	[cm <sup>3</sup> ]	[cm <sup>3</sup> ]
GPX412115	41 x 21	1.21	1.41	0.89	3.58	0.70	1.75
GPX412120	41 x 21	1.55	1.99	0.95	4.44	0.75	2.17
GPX412125	41 x 21	1.71	2.28	1.32	5.54	1.03	2.70
GPX414115	41 X 41	1.65	2.42	4.88	5.99	2.05	2.92
GPX414120	41 x 41	2.09	2.65	5.84	7.62	2.46	3.72
GPX414125	41 x 41	2.53	3.28	7.08	9.25	2.98	4.51
GPX2M412120	41 x 21	1.55	1.99	0.95	4.44	0.75	2.17
GPX2M414120	41 x 41	2.09	2.65	5.84	7.62	2.46	3.72
SPX412115	41 x 21	1,88	2.28	1.32	5.54	1.03	2.70
SPX412130	41 x 21	1,88	2.28	1.32	5.54	1.03	2.70
SPX412145	41 x 21	1,88	2.28	1.32	5.54	1.03	2.70
SPX414115	41 x 41	2,70	3.28	7.08	9.25	2.98	4.51
SPX414130	41 x 41	2,70	3.28	7.08	9.25	2.98	4.51
SPX414145	41 x 41	2,70	3.28	7.08	9.25	2.98	4.51
SPX414160	41 x 41	2,70	3.28	7.08	9.25	2.98	4.51
SPX414175	41 x 41	2,70	3.28	7.08	9.25	2.98	4.51
SPX414110	41 x 41	2,70	3.28	7.08	9.25	2.98	4.51

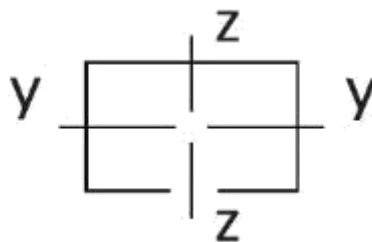

## 5. HYPOTHÈSES DE CALCUL ET CHARGES

### HYPOTHÈSES DE CALCUL POUR RAILS GP-X

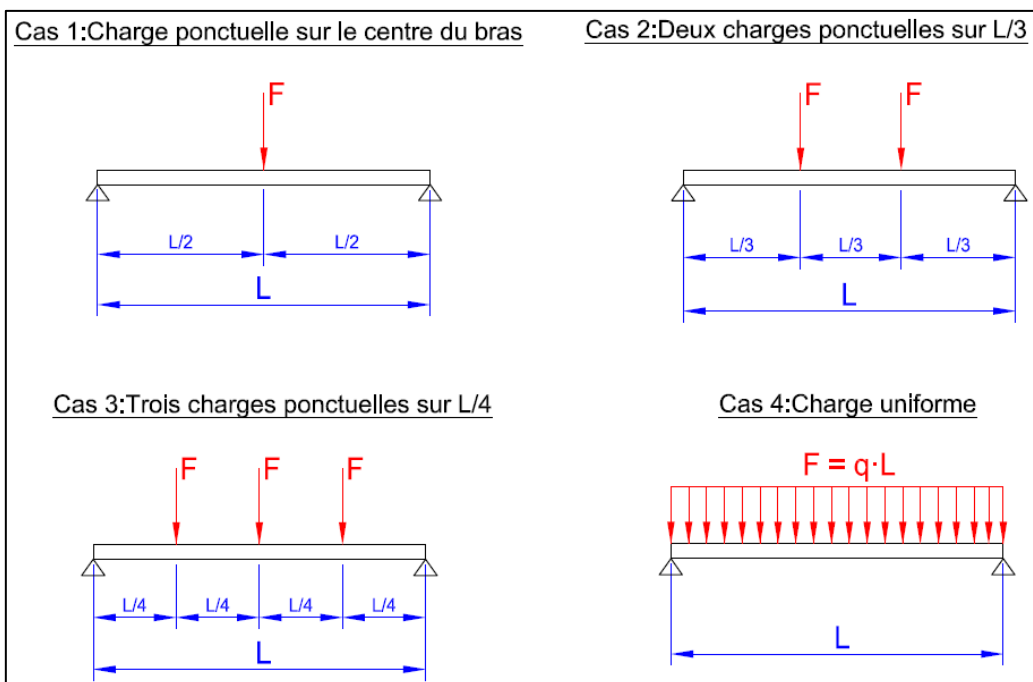

### HYPOTHÈSES DE CALCUL POUR CONSOLE RAILS SP-X

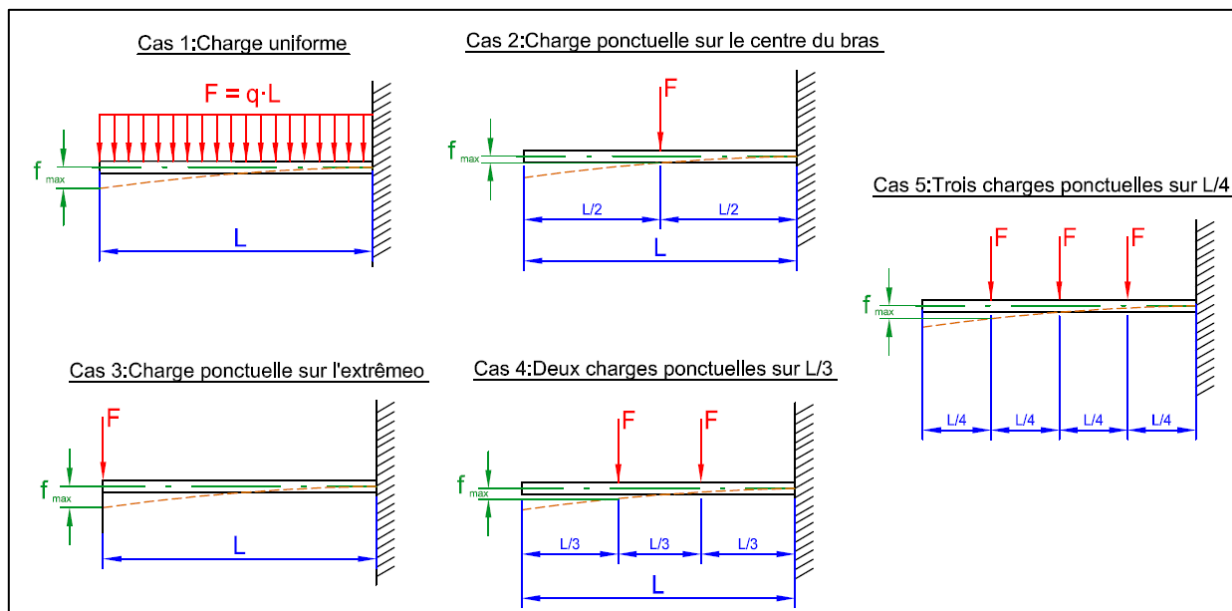

CHARGES MAXIMALES RECOMANDEE POUR RAILS PERFORE GP-X

Rail 412115

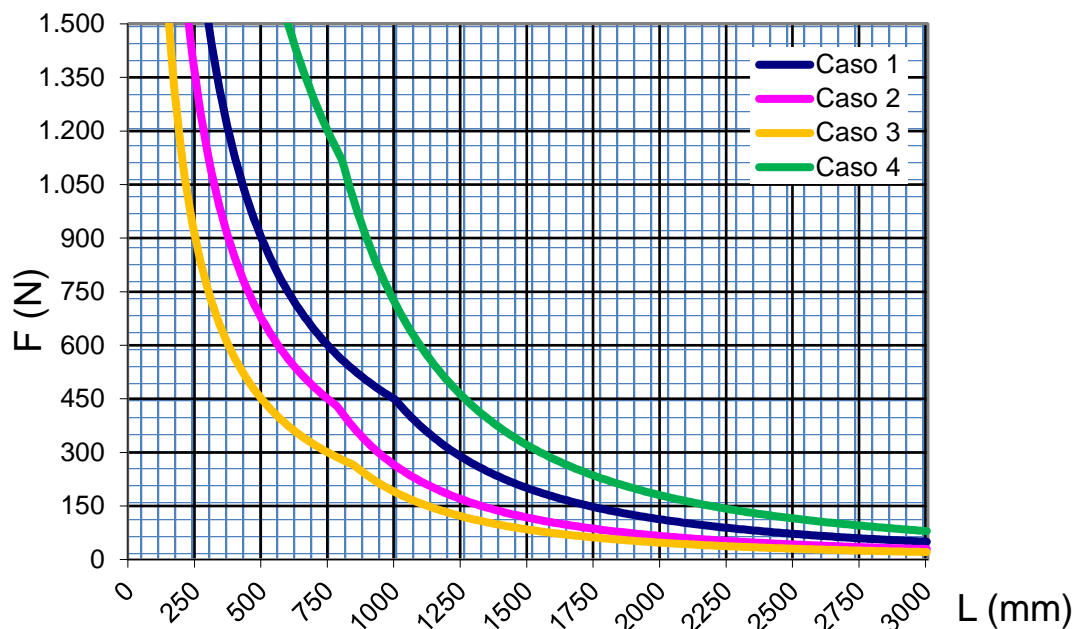

Rail 412120

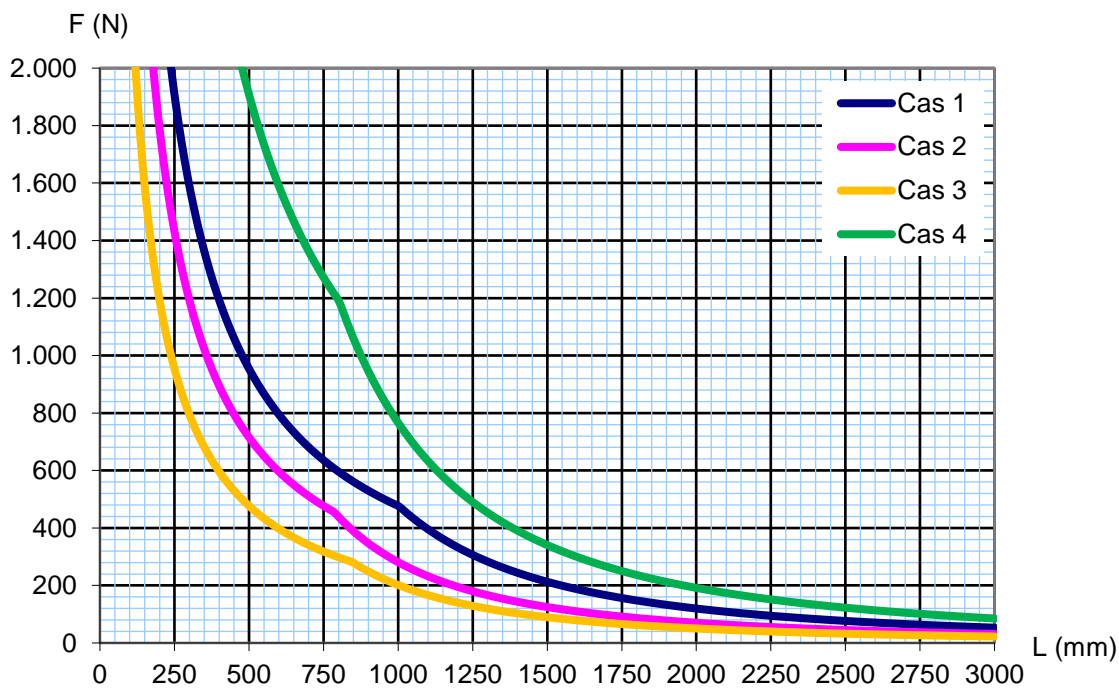

Rail 412125

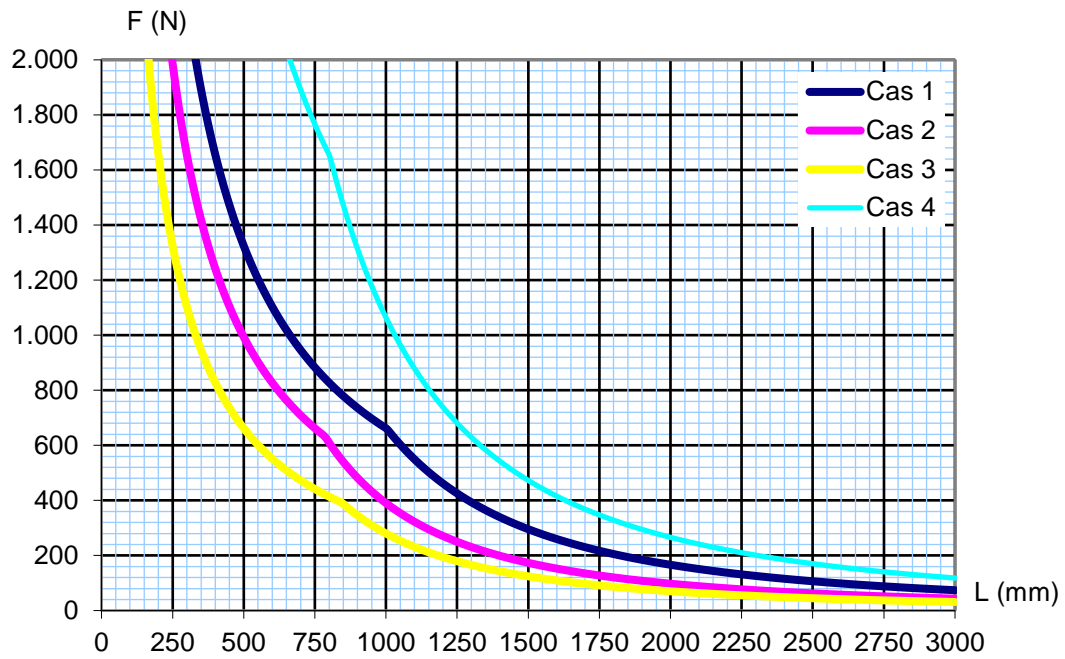

Rail 414115

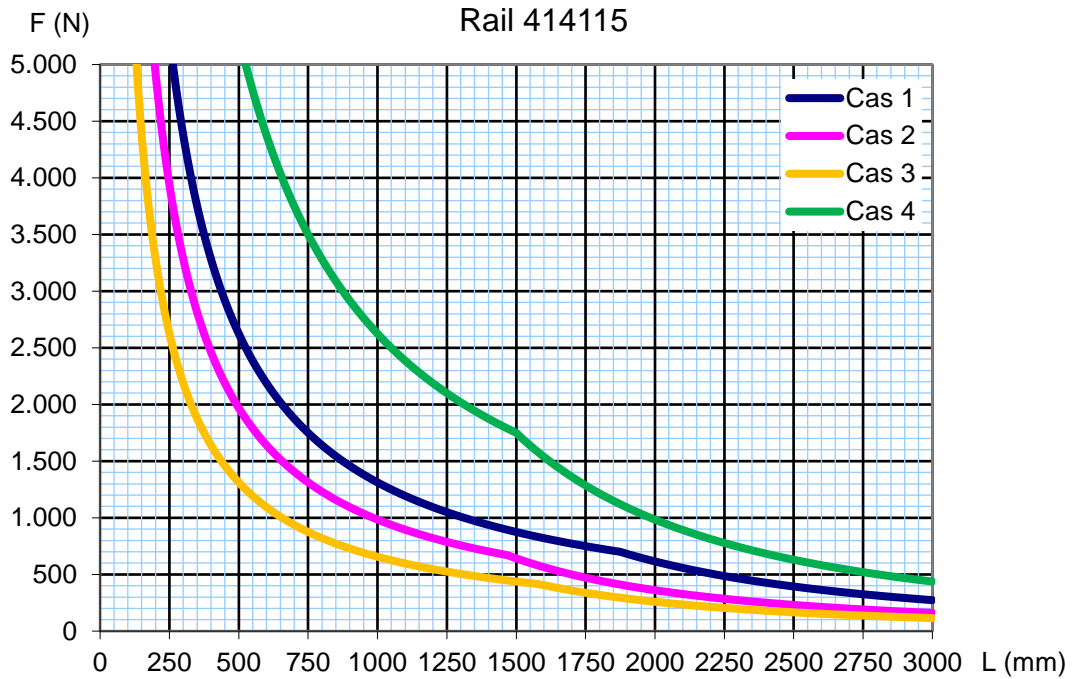

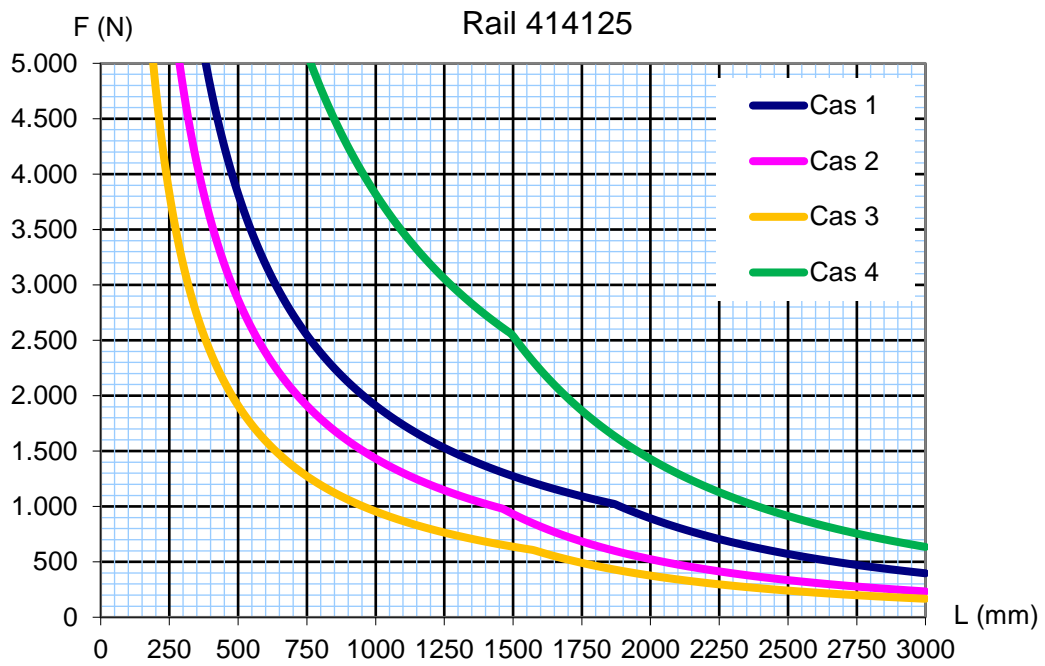
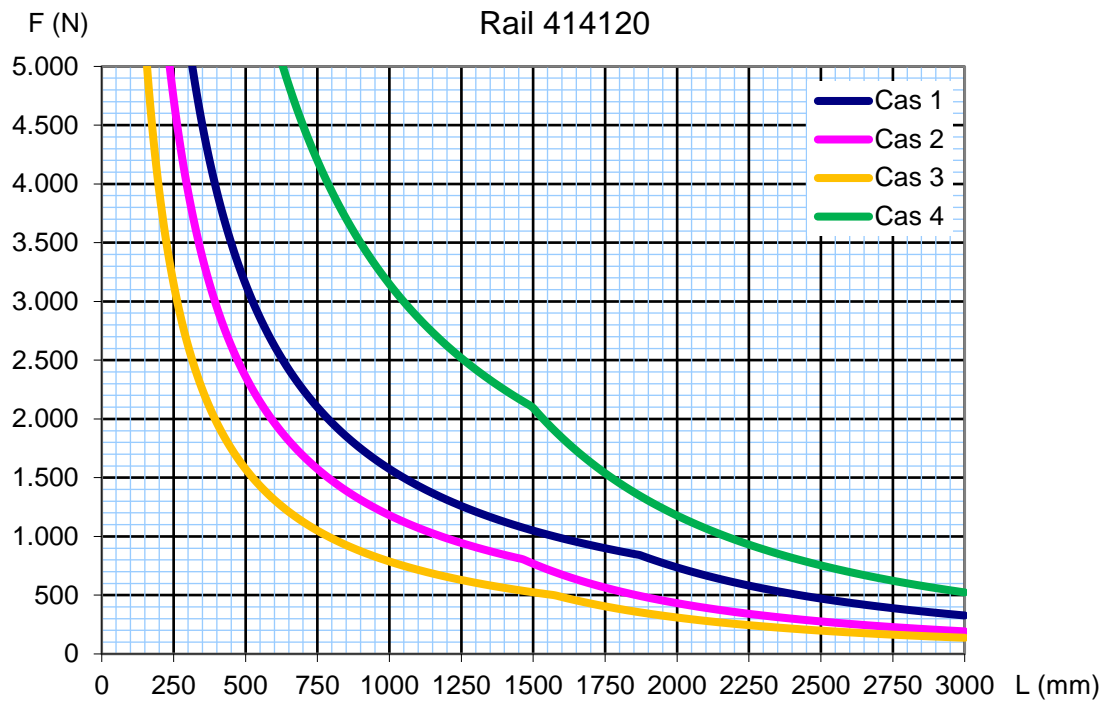

CHARGES MAXIMALES RECOMANDEE POUR CONSOLE RAILS SP-X

Console rail 41/21

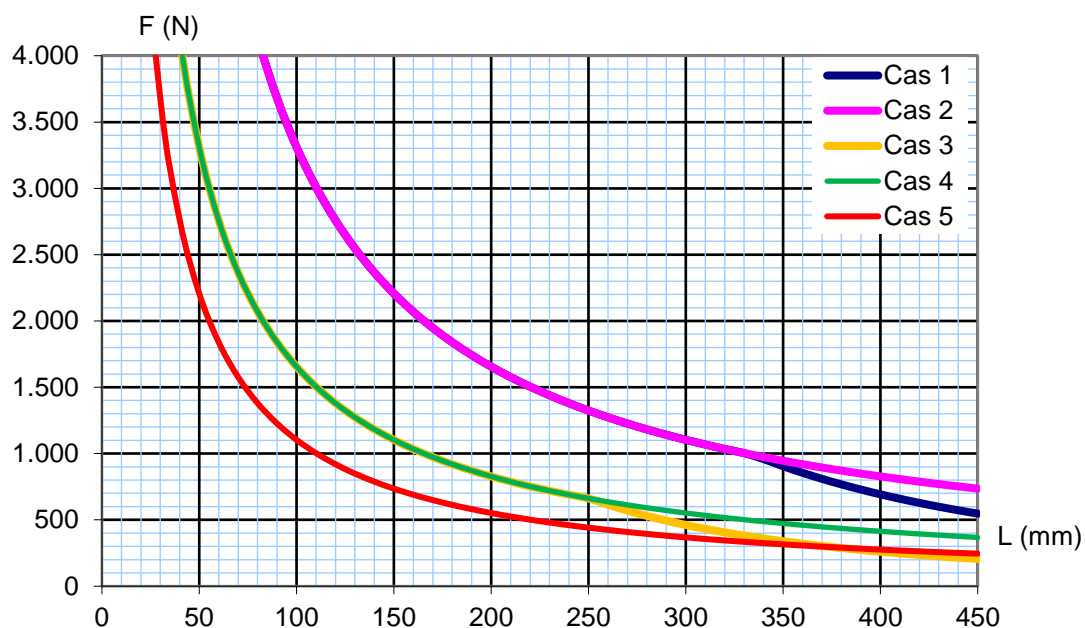

Console rail 41/41

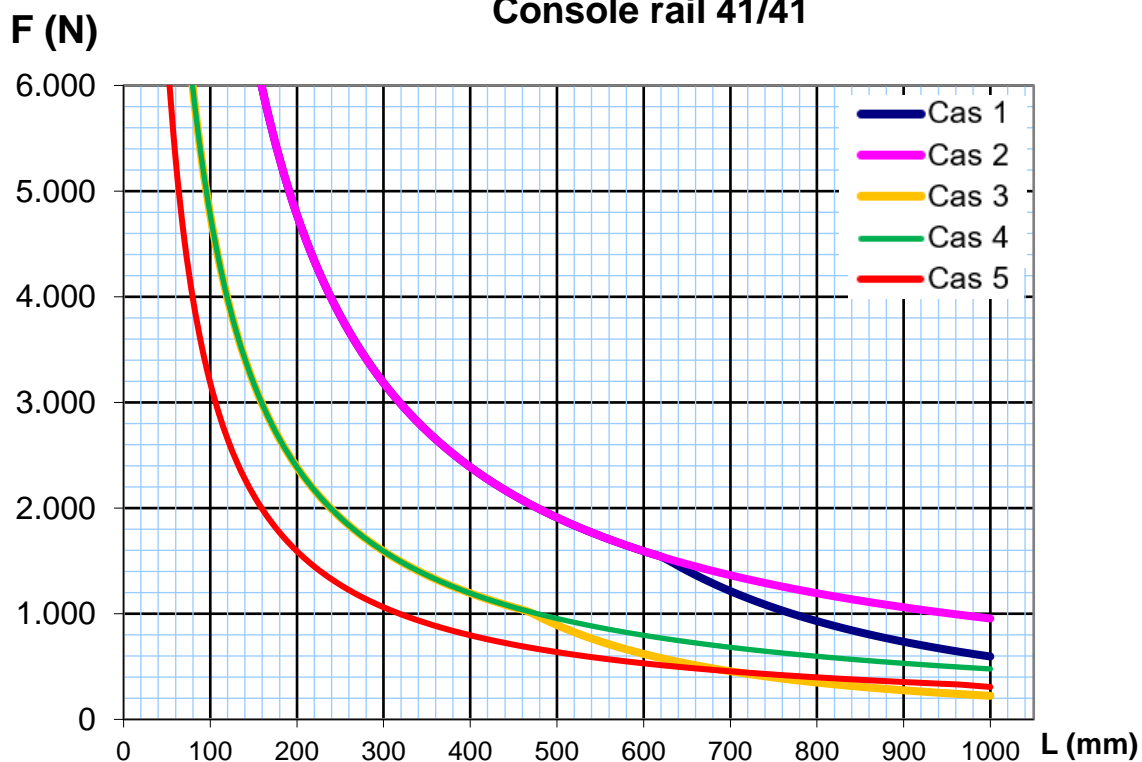



EXEMPLE DE CALCUL POUR RAIL PERFORE

**Exemple de calcul rail perforé:**

Rail GPX414125: Longueur de rail 800 mm avec trois colliers équidistants situés à 200 mm (cas N° 3).

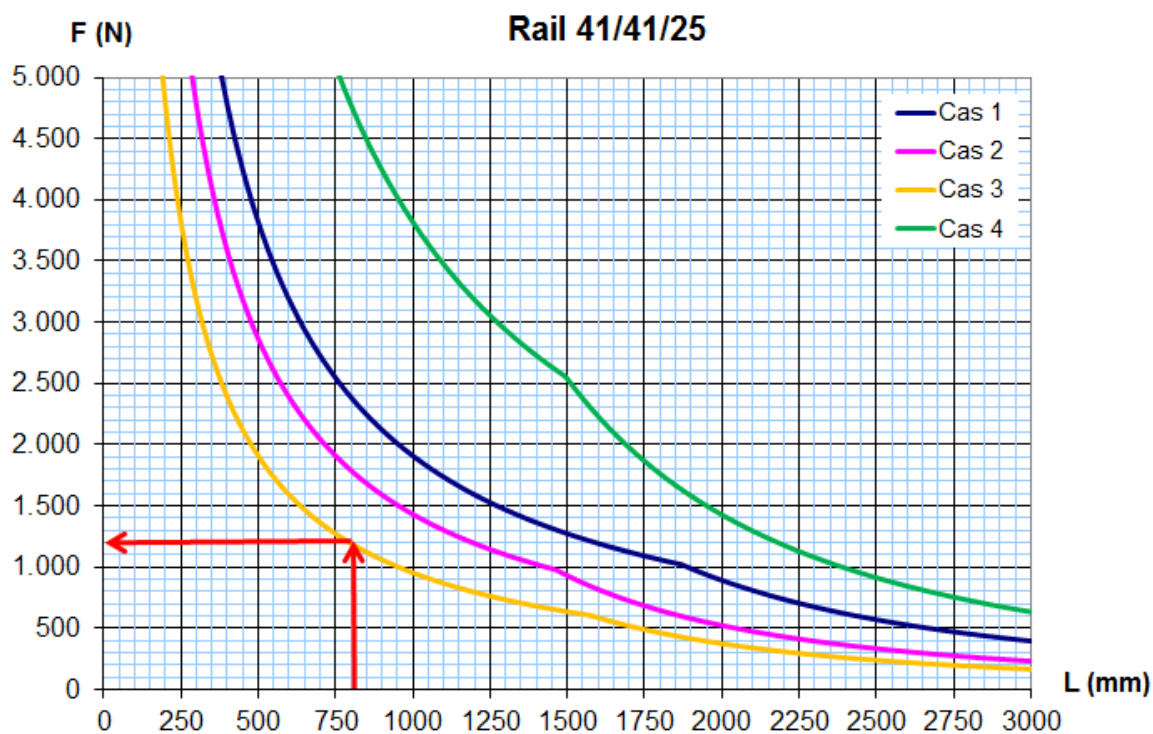
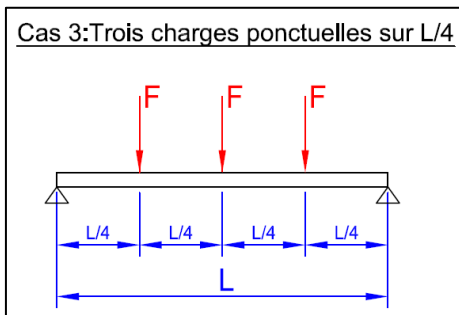

Il en résulte une charge admissible par collier de 1.200 N (≈120 Kg).

EXEMPLE DE CALCUL POUR CONSOLE RAIL

**Exemple de calcul console rail perforé:**

Console rail SPX414130: Un seul tuyau situé à 300 mm de la paroi (cas N°2).

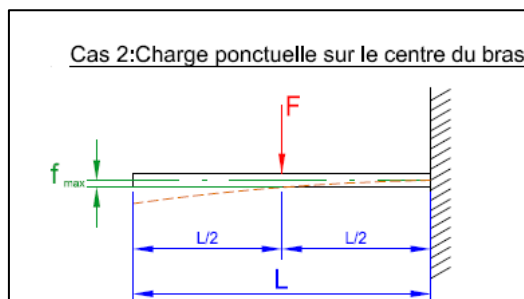

Console rail 41/41

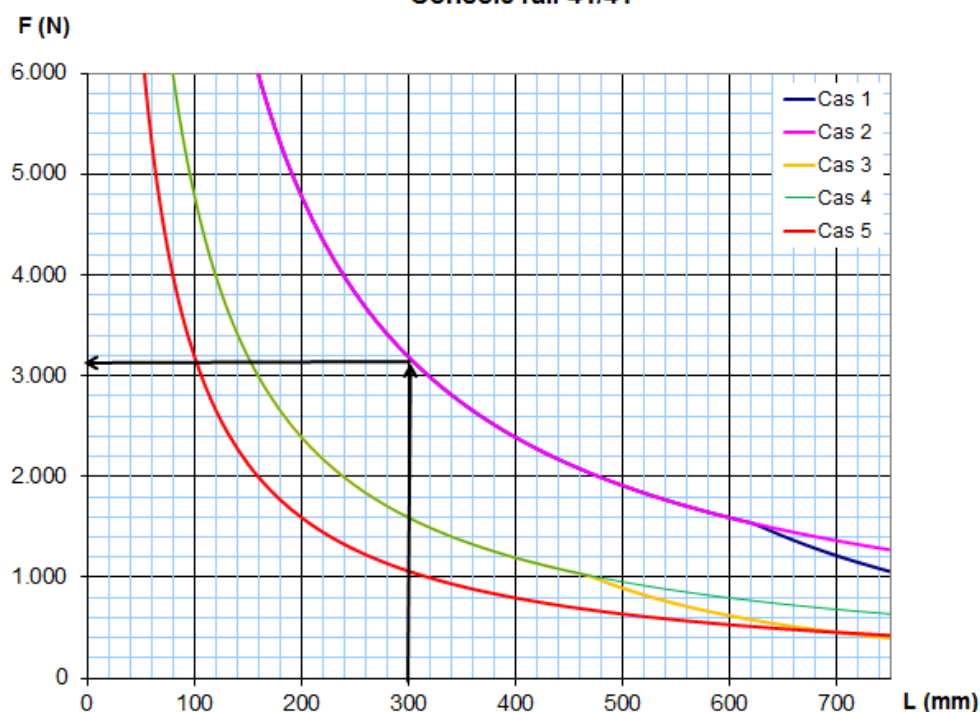

Il en résulte une charge admissible de 3.180N (≈318 Kg).

Ces charges admissibles ne peuvent s'appliquer que si les Console rails sont fixés avec des ancrages qui remplissent les conditions d'emploi et d'application de ceux-ci.

Par ailleurs, on doit vérifier que les forces se transmettent au matériau de base (acier ou béton)

Chevilles recommandées : AH08075, AH10090, MIA408075, MIA410090, HEHOM08 y HEHOM10