

1

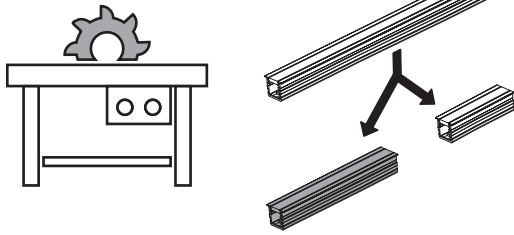

2



Please choose the direction of lampshade insertion according to actual needs.

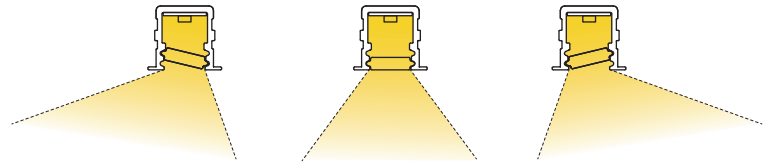

3

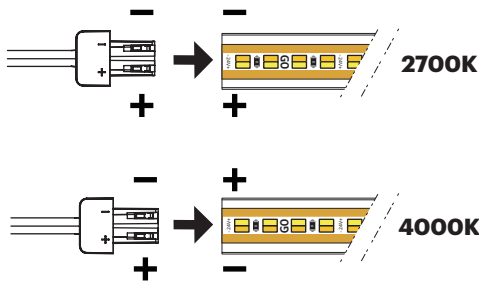

IR SENSOR

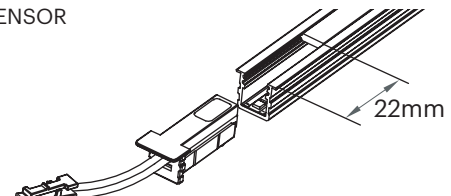

DC24V 1.5A MAX

CONNECTION CORD

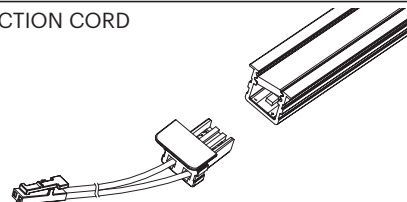

DC24V 3A MAX

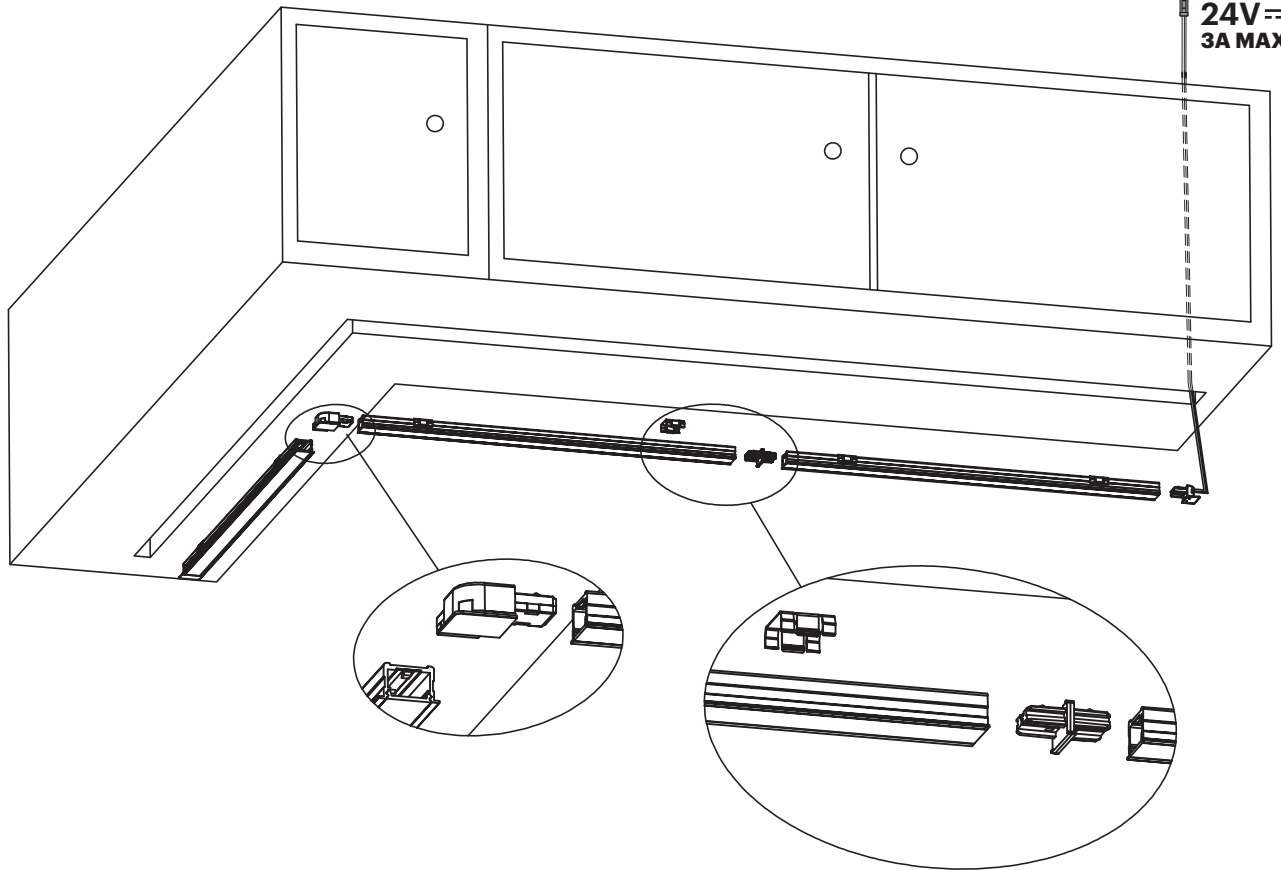
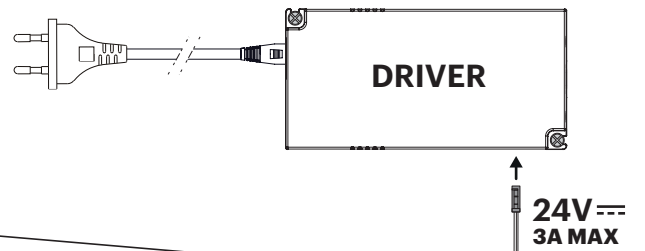
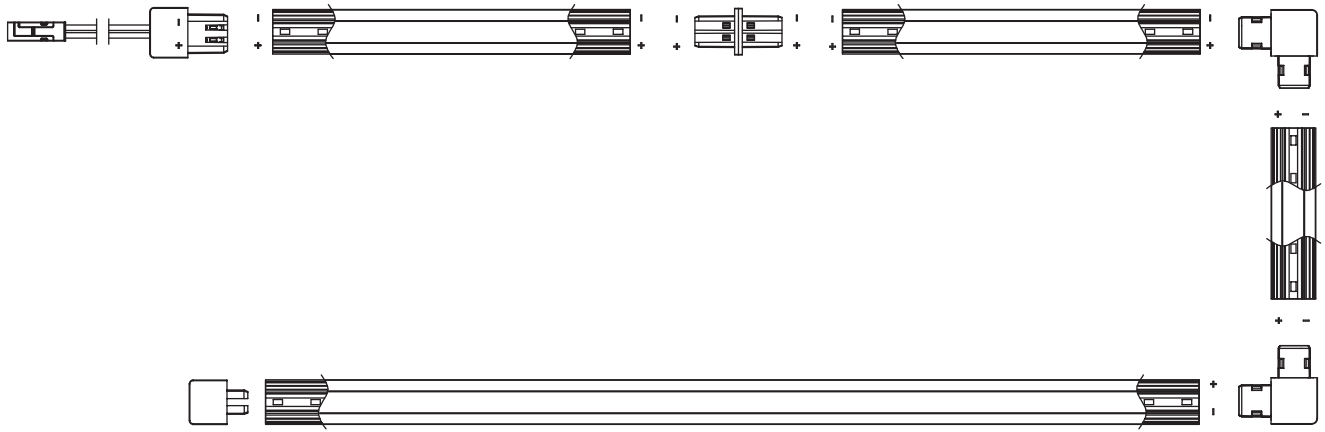

IR SENSOR

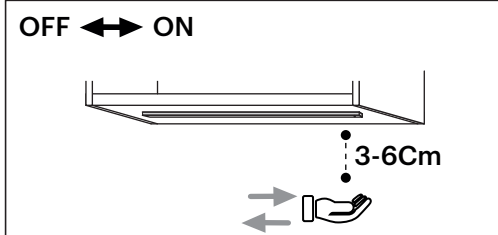

DIMMER

