

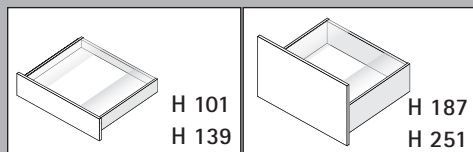















































AvanTech YOU

Illumination



Technik für Möbel



 	de	3
 	en	4
 	fr	5
 	es	6
 	pt	7
 	cs	8
 	it	9
 	bg	10
 	da	11
 	sv	12
 	sk	13
 	nl	14
 	pl	15
 	tr	16
 	zh	17
 	sl	18
 	hr	19
 	hu	20
 	el	21
 	lt	22
 	fi	23
 	ro	24
 	ru	25
 	ar	26



27 - 31



www.hettich.com/short/8815e9

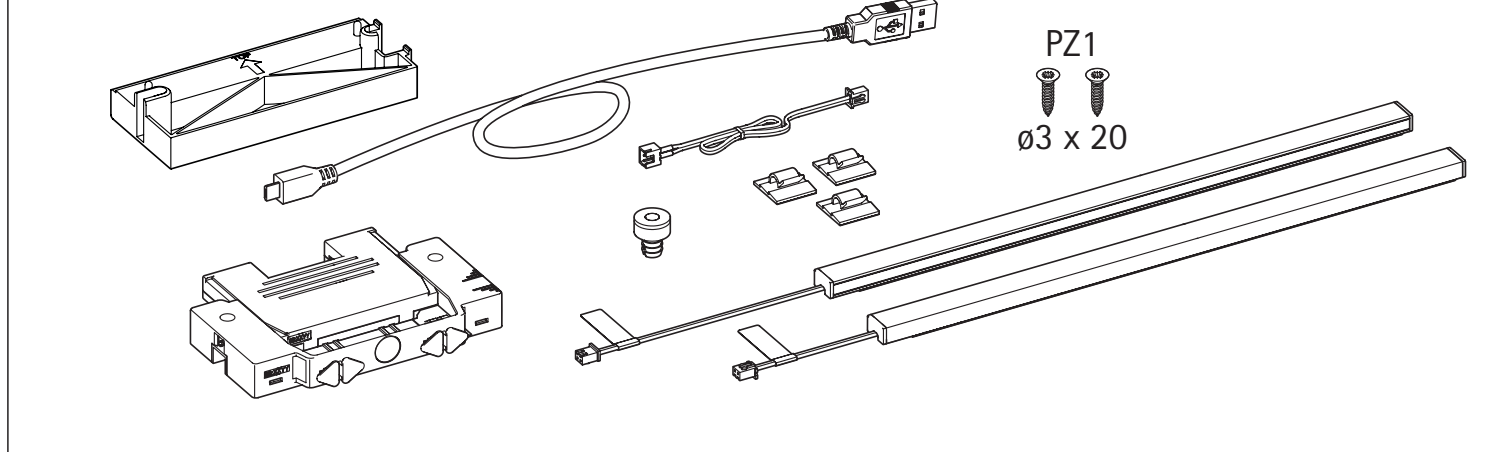

Caractéristiques techniques :

Tension de service : 7,5 V DC

Tension de sortie : 7,5 V DC

Classe de protection : III

Couleur de la lumière : 4000 K

Classe de protection IP : 20

Longueur nominale NL (mm)	Puissance absorbée
450	2x 0,91 W
500	2x 0,98 W
550	2x 1,01 W
650	2x 1,32 W



Consignes de sécurité :

1. Seuls les matériaux d'installation ou les accessoires du système approuvés peuvent être utilisés lors du montage.
2. Les dommages dus à un raccordement incorrect ne sont pas couverts par la garantie.
3. Il faut poser les câbles de façon à ce que les points de raccordement ne soient pas soumis à une traction.
4. Si un flexible extérieur est endommagé, seul le fabricant ou son S.A.V. est autorisé à le remplacer.
5. Aucun droit à la garantie en cas de modifications effectuées par vos propres soins.

Conserver les instructions de montage !

Veuillez conserver ces instructions de montage même après le montage pour pouvoir effectuer d'éventuelles modifications ultérieures de manière conforme.



Une mise au rebut avec les déchets domestiques habituels est interdite ! La mise au rebut doit avoir lieu conformément à la réglementation locale relative à l'élimination des déchets / au recyclage.



Risques d'incendie et d'explosion

Légères blessures et brûlures causées par une utilisation incorrecte des batteries en bon état de fonctionnement et des batteries défectueuses.

- Il est interdit de court-circuiter les batteries et de les poser sur des objets conducteurs, car cela pourrait provoquer un court-circuitage.
- Il est interdit de charger et d'utiliser des batteries présentant des dommages mécaniques ou autres.
- Protéger les batteries de l'humidité et de la chaleur.
- Utiliser uniquement des chargeurs ou des interfaces USB de 5 V et d'au moins 1 A.
- Ne pas charger les batteries pendant plus de 8 heures.

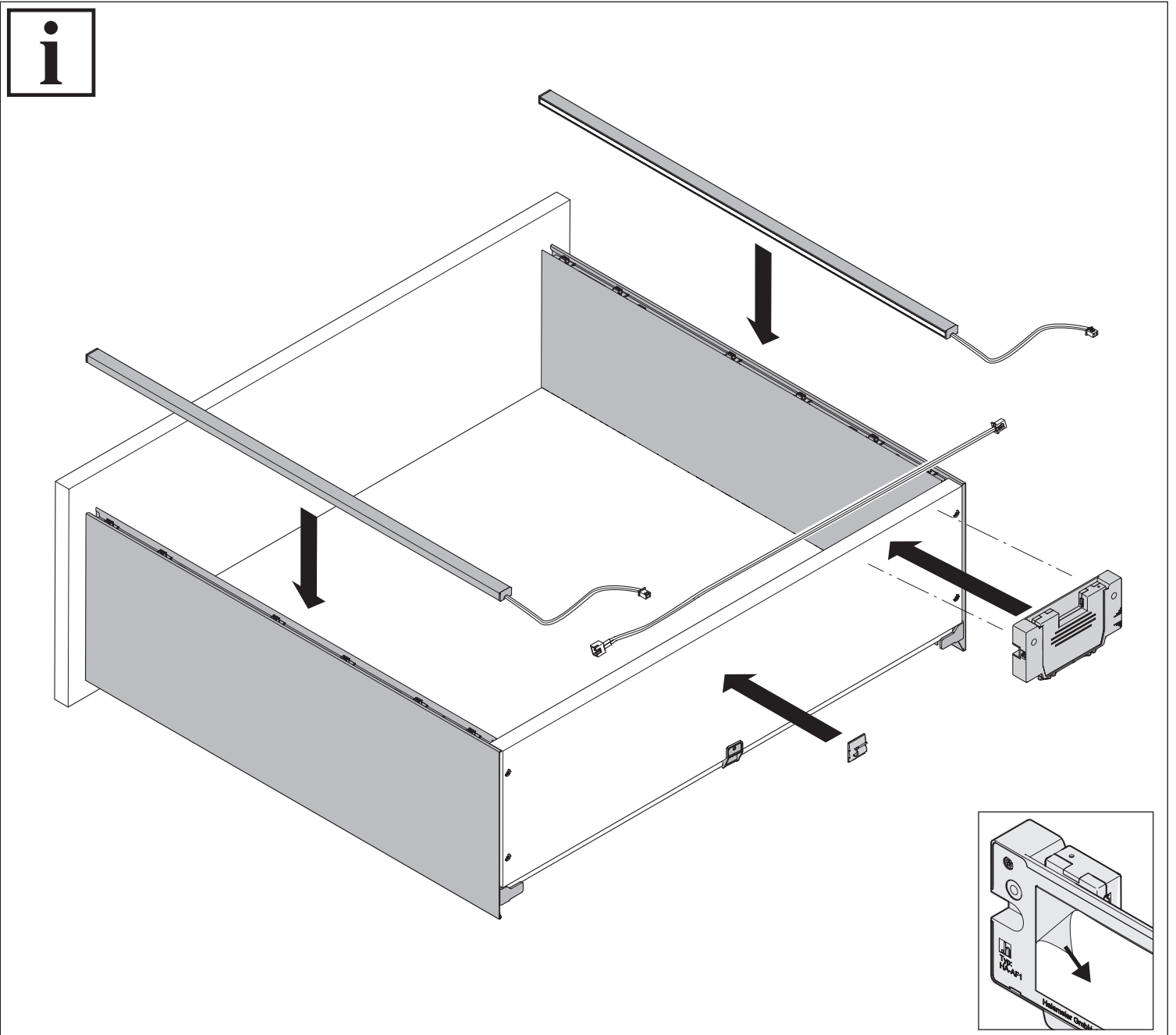
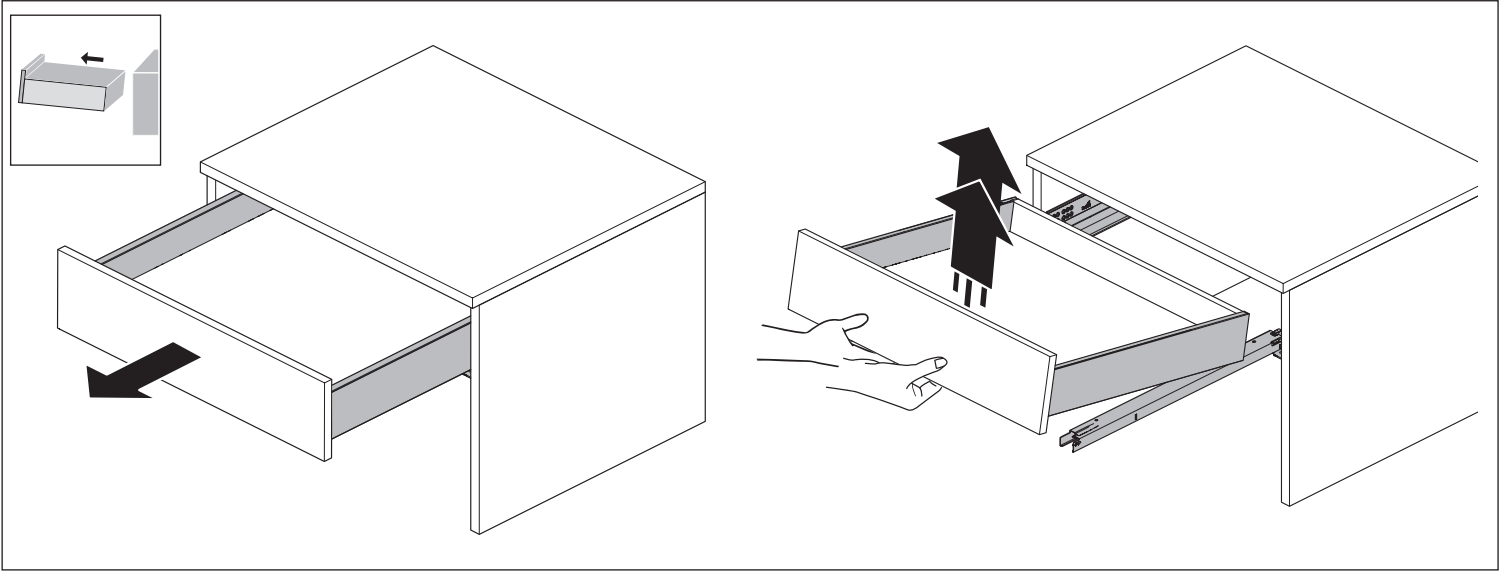

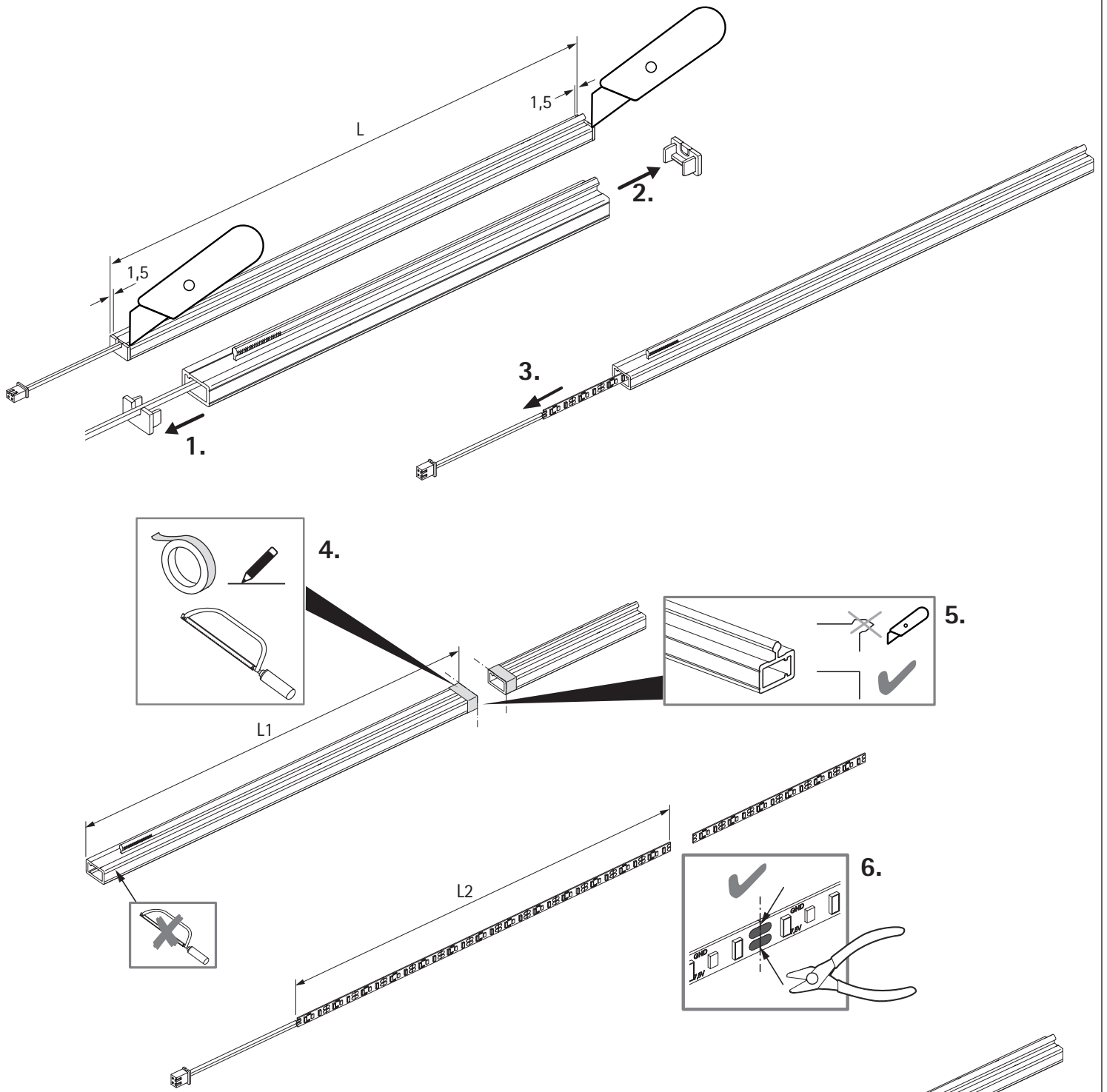
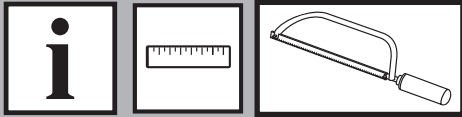

NL	L	L1	L2
270	260	257	247
300	290	287	277
350	340	337	327
400	390	387	377
450	440	437	427
500	490	487	477
550	540	537	527
600	590	587	577
650	640	637	627

