

## Goujon d'ancrage FBN II



### Applications

#### **Agrément:**

- Béton non fissuré C20/25 à C50/60

#### **Convient également à :**

- Béton B 15, pierre naturelle à structure dense

#### **Pour fixer :**

- Constructions métalliques
- Garde-corps
- Consoles
- Echelles
- Chemins de câbles
- Machines
- Escaliers
- Portes
- Façades
- Menuiseries
- Constructions en bois

## Description

- Goujon d'ancrage pour montage traversant et en attente.
- Lorsque vous serrez l'écrou hexagonal, le goujon fileté est ramené dans la bague d'expansion et s'expande contre les parois du support.
- Version en acier inoxydable pour utilisation en extérieur et dans des locaux humides.
- Version GS avec rondelle large selon DIN 440 pour constructions en bois.

## **Avantages**

- Le goujon FBN II électrozingué offre la résistance la plus élevée dans un béton non fissuré - le support d'ancrage ne permet pas plus.
- La profondeur d'ancrage réduite optimise le temps de perçage - ce qui économise du temps et évite d'endommager les armatures.
- Le filetage long permet des montages à distance et des longueurs utiles variables.
- Diamètres 8 à 16 également pour profondeurs d'ancrage réduites, p.ex. en cas de faibles charges ou présence d'armatures.
- Le marquage en tête permettant d'identifier la profondeur d'ancrage garantit un contrôle après la pose.

## Exemple d'application



## Mise en œuvre

### **Type d'installation**

- Montage traversant et en attente

### **Astuces pour l'installation**

- Pour une installation en série, nous conseillons l'outil de pose pour goujon d'ancrage FABS.
- Avant le vissage, l'écrou hexagonal doit être amené dans la position de montage optimale (le goujon dépasse de 2 à 3 mm).

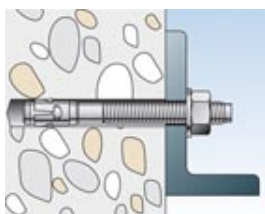
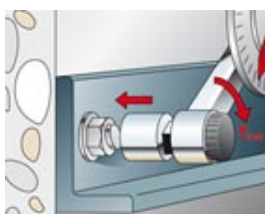
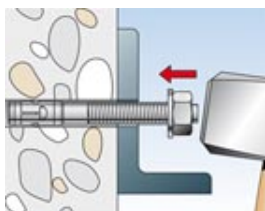
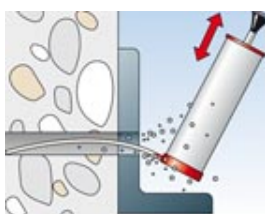

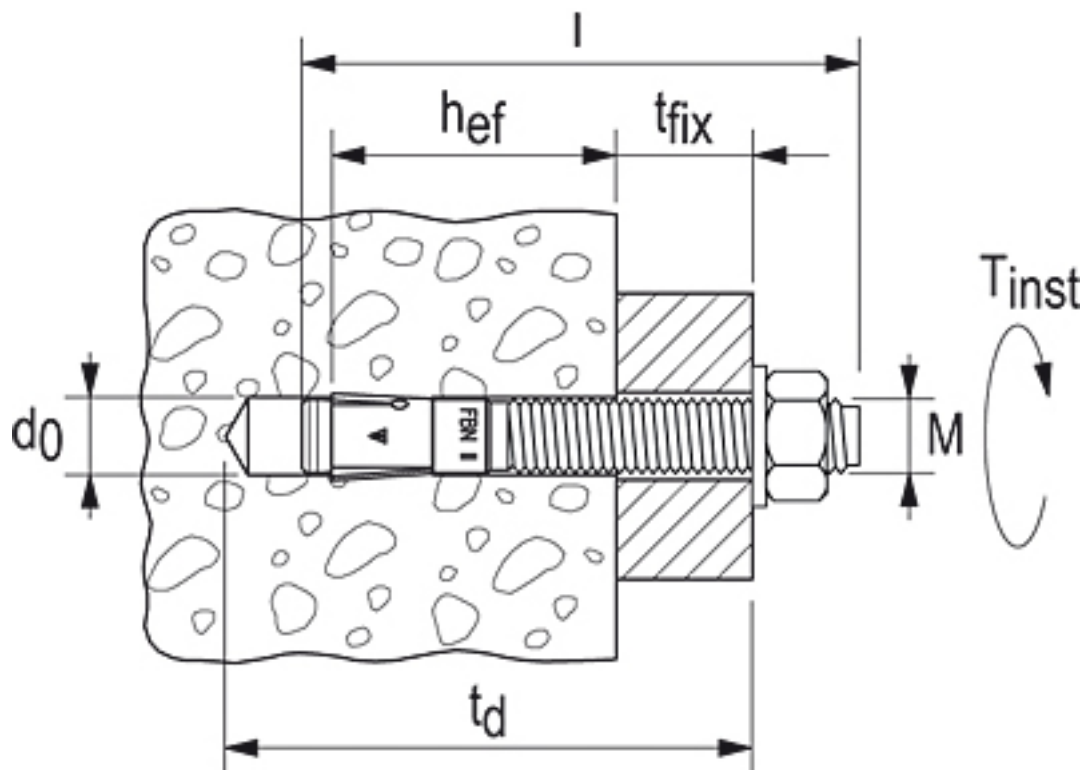

Données techniques



Type	N° Code	<input type="checkbox"/> ETA <input type="checkbox"/> DIBt	marquage de tête	foret <div class="h6">d <sub>o</sub> </div> > [mm]	profondeur de perçage mini pour fixation traversante <div class="h6">h <sub>2</sub> </div> > [mm]	<div class="h6">h <sub>ef</sub> </div> > [mm]	longueur de cheville <div class="h6">l</div> > [mm]	<div class="h6">t <sub>fix</sub> </div> > [mm]	filetage [mm]	surplat <div class="h6">#57347; SW</div> > [mm]
FBN II 8/5	040662	<input checked="" type="checkbox"/>	A	8	61	40 / 30	66	5/15	M 8 x 34	13
FBN II 8/10	040664	<input checked="" type="checkbox"/>	B	8	66	40 / 30	71	10/20	M 8 x 39	13
FBN II 8/20	040669	<input checked="" type="checkbox"/>	D	8	76	40 / 30	81	20/30	M 8 x 49	13
FBN II 8/30	040700	<input checked="" type="checkbox"/>	F	8	86	40 / 30	91	30/40	M 8 x 59	13
FBN II 8/50	040771	<input checked="" type="checkbox"/>	K	8	106	40 / 30	111	50/60	M 8 x 79	13

Type	N° Code	ETA DIBt	marquage de tête	foret <div class="h6">d <sub>0</sub> </div> > [mm]	profondeur de perçage mini pour fixation traversante <div class="h6">h <sub>2</sub> </div> > [mm]	<div class="h6">h <sub>ef</sub> </div> > [mm]	longueur de cheville <div class="h6">l</div> > [mm]	<div class="h6">t <sub>fix</sub> </div> > [mm]	filetage [mm]	surplat <div class="h6">&#57347; SW</div> > [mm]
FBN II 8/70	040777	■	M	8	126	40 / 30	131	70/80	M 8 x 99	13
FBN II 8/100	040783	■	P	8	156	40 / 30	161	100/110	M 8 x 129	13
FBN II 10/10	040827	■	B	10	78	50 / 40	86	10/20	M 10 x 46	17
FBN II 10/20	040851	■	D	10	88	50 / 40	96	20/30	M 10 x 56	17
FBN II 10/30	040854	■	F	10	98	50 / 40	106	30/40	M 10 x 66	17
FBN II 10/50	040855	■	K	10	118	50 / 40	126	50/60	M 10 x 86	17
FBN II 10/70	040931	■	M	10	138	50 / 40	146	70/80	M 10 x 106	17
FBN II 10/100	040943	■	P	10	168	50 / 40	176	100/110	M 10 x 136	17
FBN II 10/140	040944	■	S	10	208	50 / 40	216	140/150	M 10 x 176	17
FBN II 10/160	040945	■	T	10	228	50 / 40	236	160/170	M 10 x 196	17
FBN II 12/10	040950	■	B	12	95	65 / 50	106	10/25	M 12 x 59	19
FBN II 12/20	044558	■	D	12	105	65 / 50	116	20/35	M 12 x 69	19
FBN II 12/30	045263	■	F	12	115	65 / 50	126	30/45	M 12 x 79	19
FBN II 12/50	045264	■	K	12	135	65 / 50	146	50/65	M 12 x 99	19
FBN II 12/80	045265	■	N	12	165	65 / 50	176	80/95	M 12 x 129	19
FBN II 12/100	045266	■	P	12	185	65 / 50	196	100/115	M 12 x 149	19
FBN II 12/120	045267	■	R	12	205	65 / 50	216	120/135	M 12 x 169	19
FBN II 12/140	045268	■	S	12	225	65 / 50	236	140/155	M 12 x 189	19
FBN II 12/160	045269	■	T	12	245	65 / 50	256	160/175	M 12 x 189	19
FBN II 16/25	045564	■	E	16	129	80 / 65	145	25/40	M 16 x 89	24
FBN II 16/50	045565	■	K	16	154	80 / 65	170	50/65	M 16 x 105	24
FBN II 16/80	045566	■	N	16	184	80 / 65	200	80/95	M 16 x 144	24
FBN II 16/100	045567	■	P	16	204	80 / 65	220	100/115	M 16 x 164	24
FBN II 16/140	045568	■	S	16	244	80 / 65	260	140/155	M 16 x 184	24
FBN II 16/160	045569	■	T	16	264	80 / 65	280	160/175	M 16 x 184	24
FBN II 16/200	045570	■	V	16	304	80 / 65	320	200/215	M 16 x 100	24
FBN II 20/30	045573	■	F	20	165	105 / 80	187	30/55	M 20 x 90	30
FBN II 20/60	045574	■	L	20	195	105 / 80	217	60/85	M 20 x 90	30

Type	N° Code	<div style="display: flex; align-items: center; gap: 5px;"> <div style="width: 10px; height: 10px; background-color: #0070C0; border: 1px solid black; margin-right: 5px;"></div> ETA           <div style="width: 10px; height: 10px; background-color: #D9534F; border: 1px solid black; margin-right: 5px;"></div> DIBt         </div>	marquage de tête	foret <div class="h6">d <sub>0</sub> </div> > [mm]	profondeur de perçage mini pour fixation traversante <div class="h6">h <sub>2</sub> </div> > [mm]	<div class="h6">h <sub>ef</sub> </div> > [mm]	longueur de cheville <div class="h6">l</div> > [mm]	<div class="h6">t <sub>fix</sub> </div> > [mm]	filetage [mm]	surplat <div class="h6">&#57347; SW</div> > [mm]
FBN II 20/80	045575	<div style="display: flex; align-items: center; gap: 5px;"><div style="width: 10px; height: 10px; background-color: #0070C0; border: 1px solid black;"></div><div style="width: 10px; height: 10px; background-color: #D9534F; border: 1px solid black;"></div></div>	M	20	215	105 / 80	237	80/105	M 20 x 90	30
FBN II 20/120	045576	<div style="display: flex; align-items: center; gap: 5px;"><div style="width: 10px; height: 10px; background-color: #0070C0; border: 1px solid black;"></div><div style="width: 10px; height: 10px; background-color: #D9534F; border: 1px solid black;"></div></div>	R	20	255	105 / 80	277	120/145	M 20 x 90	30
FBN II 8/5 K	040806	<div style="display: flex; align-items: center; gap: 5px;"><div style="width: 10px; height: 10px; background-color: #0070C0; border: 1px solid black;"></div><div style="width: 10px; height: 10px; background-color: #D9534F; border: 1px solid black;"></div></div>	-A-	8	51	30 / -	56	5/-	M 8 x 24	13
FBN II 8/10 K	040807	<div style="display: flex; align-items: center; gap: 5px;"><div style="width: 10px; height: 10px; background-color: #0070C0; border: 1px solid black;"></div><div style="width: 10px; height: 10px; background-color: #D9534F; border: 1px solid black;"></div></div>	-B-	8	56	30 / -	61	10 / -	M 8 x 29	13
FBN II 8/30 K	040826	<div style="display: flex; align-items: center; gap: 5px;"><div style="width: 10px; height: 10px; background-color: #0070C0; border: 1px solid black;"></div><div style="width: 10px; height: 10px; background-color: #D9534F; border: 1px solid black;"></div></div>	-F-	8	76	40 / -	81	30/-	M 8 x 49	13
FBN II 10/5 K	040946	<div style="display: flex; align-items: center; gap: 5px;"><div style="width: 10px; height: 10px; background-color: #0070C0; border: 1px solid black;"></div><div style="width: 10px; height: 10px; background-color: #D9534F; border: 1px solid black;"></div></div>	-A-	10	63	40 / -	71	5/-	M 10 x 31	17
FBN II 10/10 K	040947	<div style="display: flex; align-items: center; gap: 5px;"><div style="width: 10px; height: 10px; background-color: #0070C0; border: 1px solid black;"></div><div style="width: 10px; height: 10px; background-color: #D9534F; border: 1px solid black;"></div></div>	-B-	10	68	40 / -	76	10 / -	M 10 x 36	17
FBN II 10/30 K	040948	<div style="display: flex; align-items: center; gap: 5px;"><div style="width: 10px; height: 10px; background-color: #0070C0; border: 1px solid black;"></div><div style="width: 10px; height: 10px; background-color: #D9534F; border: 1px solid black;"></div></div>	-F-	10	88	40 / -	96	30/-	M 10 x 56	17
FBN II 12/5 K	045272	<div style="display: flex; align-items: center; gap: 5px;"><div style="width: 10px; height: 10px; background-color: #0070C0; border: 1px solid black;"></div><div style="width: 10px; height: 10px; background-color: #D9534F; border: 1px solid black;"></div></div>	-A-	12	75	50 / -	86	5/-	M 12 x 39	19
FBN II 12/10 K	045273	<div style="display: flex; align-items: center; gap: 5px;"><div style="width: 10px; height: 10px; background-color: #0070C0; border: 1px solid black;"></div><div style="width: 10px; height: 10px; background-color: #D9534F; border: 1px solid black;"></div></div>	-B-	12	80	50 / -	91	10 / -	M 12 x 44	19
FBN II 12/30 K	045274	<div style="display: flex; align-items: center; gap: 5px;"><div style="width: 10px; height: 10px; background-color: #0070C0; border: 1px solid black;"></div><div style="width: 10px; height: 10px; background-color: #D9534F; border: 1px solid black;"></div></div>	-F-	12	100	50 / -	111	30/-	M 12 x 64	19
FBN II 16/15 K	045571	<div style="display: flex; align-items: center; gap: 5px;"><div style="width: 10px; height: 10px; background-color: #0070C0; border: 1px solid black;"></div><div style="width: 10px; height: 10px; background-color: #D9534F; border: 1px solid black;"></div></div>	-C-	16	104	65 / -	120	15/-	M 16 x 64	24
FBN II 16/25 K	045572	<div style="display: flex; align-items: center; gap: 5px;"><div style="width: 10px; height: 10px; background-color: #0070C0; border: 1px solid black;"></div><div style="width: 10px; height: 10px; background-color: #D9534F; border: 1px solid black;"></div></div>	-E-	16	114	65 / -	130	25/-	M 16 x 74	24
FBN II 20/10 K	045577	<div style="display: flex; align-items: center; gap: 5px;"><div style="width: 10px; height: 10px; background-color: #0070C0; border: 1px solid black;"></div><div style="width: 10px; height: 10px; background-color: #D9534F; border: 1px solid black;"></div></div>	-B-	20	120	80 / -	142	10 / -	M 20 x 50	30
FBN II 12/80 GS	045578	<div style="display: flex; align-items: center; gap: 5px;"><div style="width: 10px; height: 10px; background-color: #0070C0; border: 1px solid black;"></div><div style="width: 10px; height: 10px; background-color: #D9534F; border: 1px solid black;"></div></div>	N	12	165	65 / 50	176	80/95	M 12 x 129	19
FBN II 12/100 GS	045579	<div style="display: flex; align-items: center; gap: 5px;"><div style="width: 10px; height: 10px; background-color: #0070C0; border: 1px solid black;"></div><div style="width: 10px; height: 10px; background-color: #D9534F; border: 1px solid black;"></div></div>	P	12	185	65 / 50	196	100/115	M 12 x 149	19
FBN II 12/120 GS	045580	<div style="display: flex; align-items: center; gap: 5px;"><div style="width: 10px; height: 10px; background-color: #0070C0; border: 1px solid black;"></div><div style="width: 10px; height: 10px; background-color: #D9534F; border: 1px solid black;"></div></div>	R	12	205	65 / 50	216	120/135	M 12 x 169	19
FBN II 12/140 GS	045581	<div style="display: flex; align-items: center; gap: 5px;"><div style="width: 10px; height: 10px; background-color: #0070C0; border: 1px solid black;"></div><div style="width: 10px; height: 10px; background-color: #D9534F; border: 1px solid black;"></div></div>	S	12	225	65 / 50	236	140/155	M 12 x 189	19
FBN II 12/160 GS	045583	<div style="display: flex; align-items: center; gap: 5px;"><div style="width: 10px; height: 10px; background-color: #0070C0; border: 1px solid black;"></div><div style="width: 10px; height: 10px; background-color: #D9534F; border: 1px solid black;"></div></div>	T	12	245	65 / 50	256	160/175	M 12 x 189	19
FBN II 12/180 GS	045584	<div style="display: flex; align-items: center; gap: 5px;"><div style="width: 10px; height: 10px; background-color: #0070C0; border: 1px solid black;"></div><div style="width: 10px; height: 10px; background-color: #D9534F; border: 1px solid black;"></div></div>	U	12	265	65 / 50	276	180/195	M 12 x 189	19
FBN II 12/200 GS	045585	<div style="display: flex; align-items: center; gap: 5px;"><div style="width: 10px; height: 10px; background-color: #0070C0; border: 1px solid black;"></div><div style="width: 10px; height: 10px; background-color: #D9534F; border: 1px solid black;"></div></div>	V	12	285	65 / 50	296	200/215	M 12 x 189	19
FBN II 12/250 GS	045586	<div style="display: flex; align-items: center; gap: 5px;"><div style="width: 10px; height: 10px; background-color: #0070C0; border: 1px solid black;"></div><div style="width: 10px; height: 10px; background-color: #D9534F; border: 1px solid black;"></div></div>	W	12	335	65 / 50	346	250/265	M 12 x 100	19
FBN II 16/80 GS	045587	<div style="display: flex; align-items: center; gap: 5px;"><div style="width: 10px; height: 10px; background-color: #0070C0; border: 1px solid black;"></div><div style="width: 10px; height: 10px; background-color: #D9534F; border: 1px solid black;"></div></div>	N	16	184	80 / 65	200	80/95	M 16 x 144	24
FBN II 16/100 GS	045588	<div style="display: flex; align-items: center; gap: 5px;"><div style="width: 10px; height: 10px; background-color: #0070C0; border: 1px solid black;"></div><div style="width: 10px; height: 10px; background-color: #D9534F; border: 1px solid black;"></div></div>	P	16	204	80 / 65	220	100/115	M 16 x 164	24
FBN II 16/120 GS	045589	<div style="display: flex; align-items: center; gap: 5px;"><div style="width: 10px; height: 10px; background-color: #0070C0; border: 1px solid black;"></div><div style="width: 10px; height: 10px; background-color: #D9534F; border: 1px solid black;"></div></div>	R	16	224	80 / 65	240	120/135	M 16 x 184	24
FBN II 16/140 GS	045590	<div style="display: flex; align-items: center; gap: 5px;"><div style="width: 10px; height: 10px; background-color: #0070C0; border: 1px solid black;"></div><div style="width: 10px; height: 10px; background-color: #D9534F; border: 1px solid black;"></div></div>	S	16	244	80 / 65	260	140/155	M 16 x 184	24
FBN II 16/160 GS	045591	<div style="display: flex; align-items: center; gap: 5px;"><div style="width: 10px; height: 10px; background-color: #0070C0; border: 1px solid black;"></div><div style="width: 10px; height: 10px; background-color: #D9534F; border: 1px solid black;"></div></div>	T	16	264	80 / 65	280	160/175	M 16 x 184	24
FBN II 16/180 GS	045592	<div style="display: flex; align-items: center; gap: 5px;"><div style="width: 10px; height: 10px; background-color: #0070C0; border: 1px solid black;"></div><div style="width: 10px; height: 10px; background-color: #D9534F; border: 1px solid black;"></div></div>	U	16	284	80 / 65	300	180/195	M 16 x 100	24

Type	N° Code	 ETA  DIBt	marquage de tête	foret <div class="h6">d <sub>0</sub> </div> > [mm]	profondeur de perçage mini pour fixation traversante <div class="h6">h <sub>2</sub> </div> > [mm]	<div class="h6">h <sub>ef</sub> </div> > [mm]	longueur de cheville <div class="h6">l</div> > [mm]	<div class="h6">t <sub>fix</sub> </div> > [mm]	filetage	surplat <div class="h6">#57347; SW</div> > [mm]
FBN II 16/200 GS	045593		V	16	304	80 / 65	320	200/215	M 16 x 100	24