

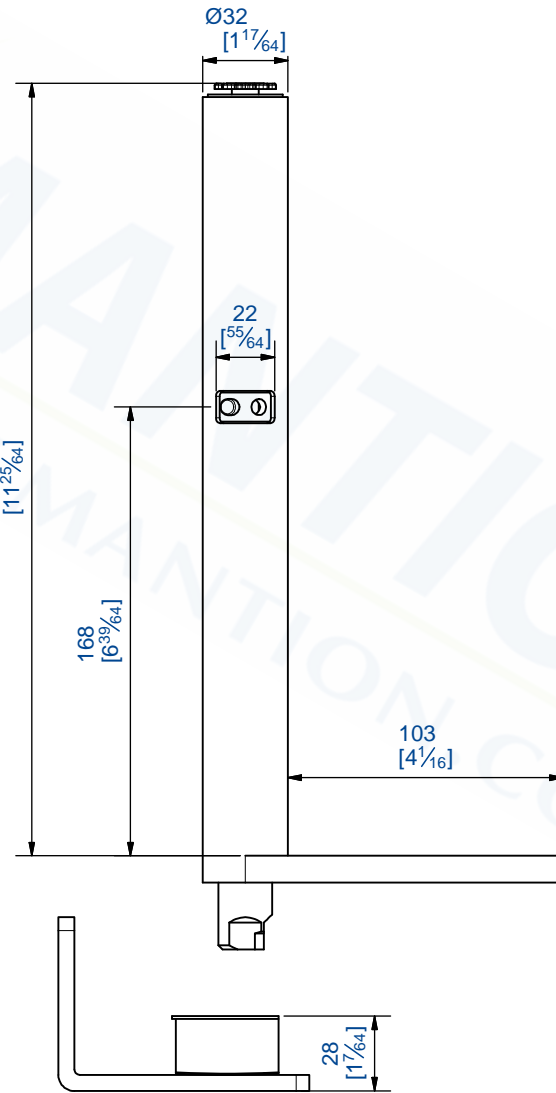

Ferme-porte
Poids du portail : 85Kg
Ouverture droite
Pour tube: □40mm

Door closer
Gate weight : 85Kg
Right opening
Tubular section: □40mm

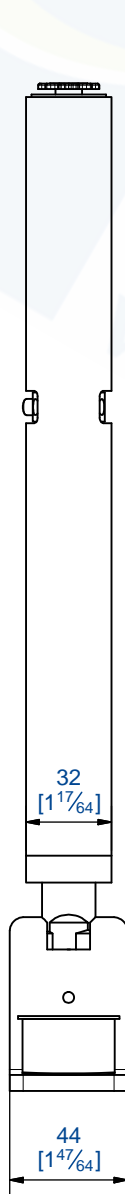
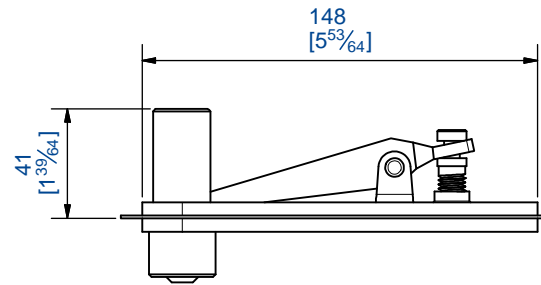
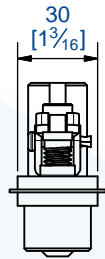

Référence Item Nr: **25312DT**

Rail associé
Combined track: