

STAFFA GRANDE DX

1

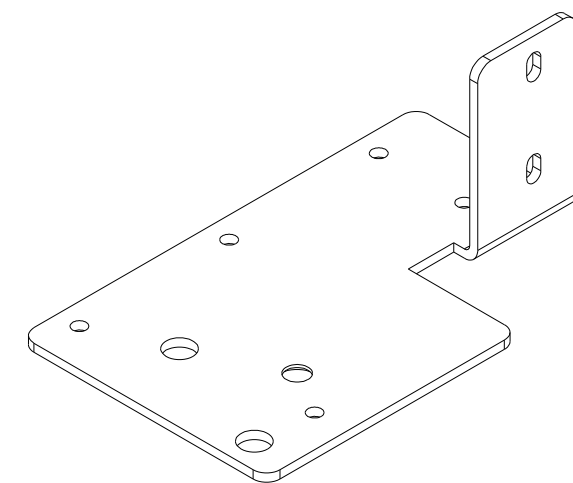

STAFFA GRANDE SX

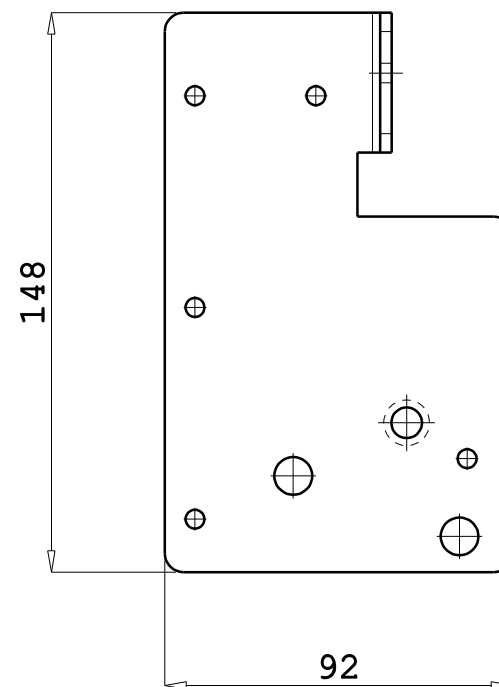
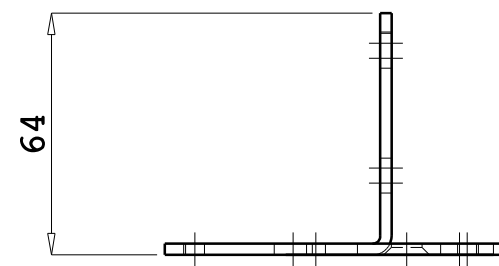
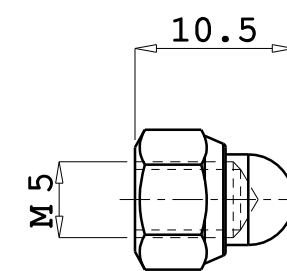
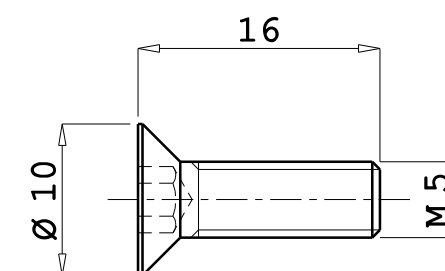
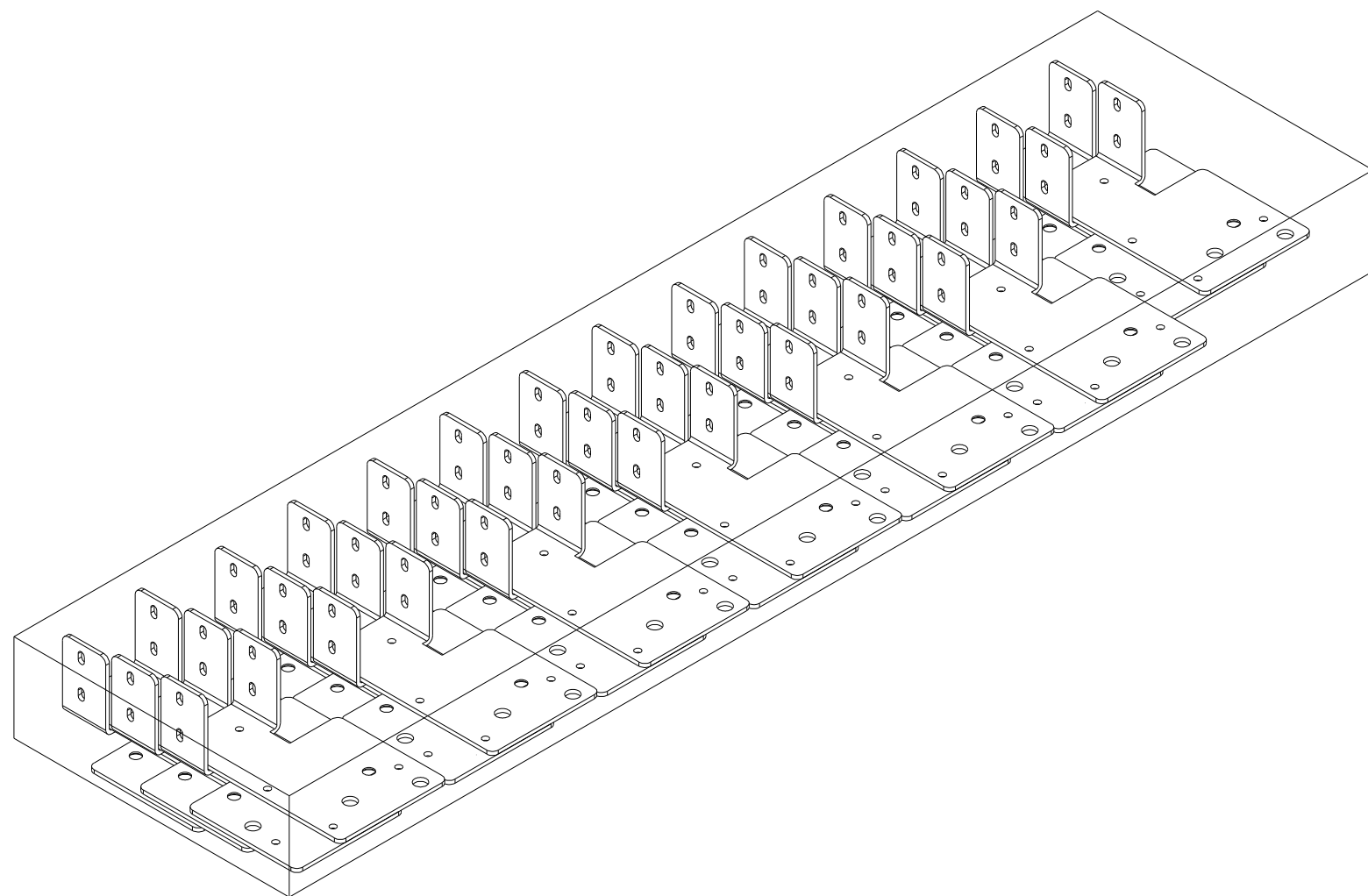

INSERIRE 20 SACCHETTI STAFFE NELLA SCATOLA

--	SCATOLA S023	1	S0023/000/00/0000/00	Comm.
01	SACCHETTO STAFFE + VITI	20	09602/000/00/0000/60	18326
N.POS.	DENOMINAZIONE PARTICOLARE	N. PEZZI	CODICE PARTICOLARE	
Disegnato	02-05-18	Beretta		
Visto	02-05-18			
Modifica 1			TOLLERANZE GENERALI LUNGH. e >18 <18 ± 0.15 ANGOLI <80 ± 0.25 >80 ± 0.50 ± 30'	
Visto				
Modifica 2			Denominazione ART.09602/000/00/0000/00 KIT STAFFE GRANDI	
Visto				
Modifica 3			N. Disegno 0 / 18323	
Visto				
Modifica 4			SCALA 1:2 2:1	
Visto				
Modifica 5				
Visto				