

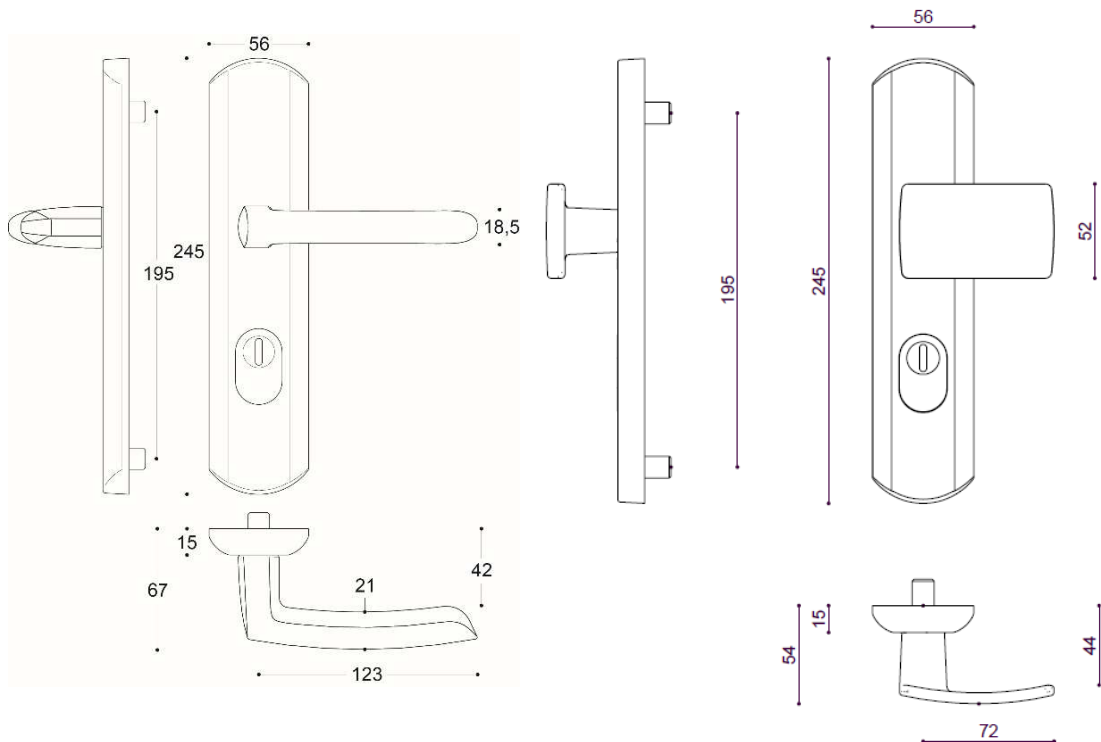



Fiche produit SCULT

Ensemble de sécurité



Gamme :









- Version double béquille ou poignée de tirage côté extérieur
- Version grande plaque
- Perçages :
 - Clé I
- Finitions :

-  - Diamant noir (*Grade 3 corrosion)
-  - Platine (*Grade 2 corrosion)
-  - Chrome velours (*Grade 4 corrosion)

Descriptif technique :

- Béquille en zamak
- Ensemble monobloc : béquille et plaque solidarisées
- Piliers taraudés intégrés avec pastille anti-perçage
- Fixations invisibles
- Protecteur de cylindre auto-adaptable au dépassant de cylindre de 10 à 15 mm
- Carré de 7mm
- Vis de fixation M6 entraxe 195mm

Qualification selon la norme EN1906-2012

							
Catégorie d'utilisation	Endurance	Masse de la porte	Résistance au feu	Sécurité des personnes	Résistance à la corrosion	Sécurité des biens	Type d'opération
2	6	--	B	1	Selon finition*	0	U

Garantie
10 ans

ASSA ABLOY, the global leader in door opening solutions*

*ASSA ABLOY, le leader mondial des solutions d'ouverture de portes