



FONCTIONNEMENT DES CONTACTS SERIES S ET J

Contact 1101 600.1101.00 1x contact NO à impulsion 1 sens

PLASTRON UTILISE

**REPOS**

--	--	--

	P	NO
--	---	----

**TRAVAIL**

--	--	--

	P	NF
--	---	----

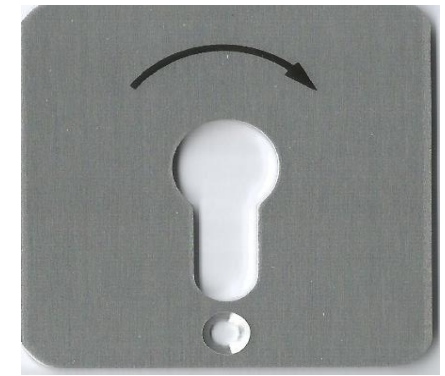
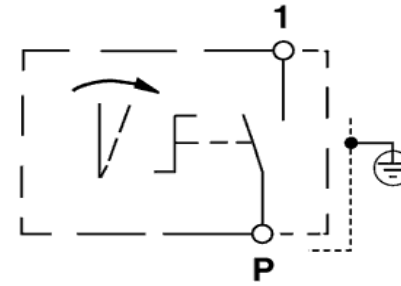
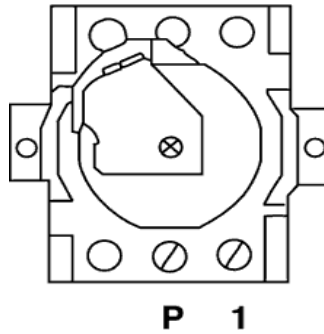

Contact 1102 600.1102.00 2 double contacts NO à impulsion 1 sens

PLASTRON UTILISE

**REPOS**

NO	P1	
----	----	--

	P	NO
--	---	----

**TRAVAIL**

NF	P1	
----	----	--

	P	NF
--	---	----

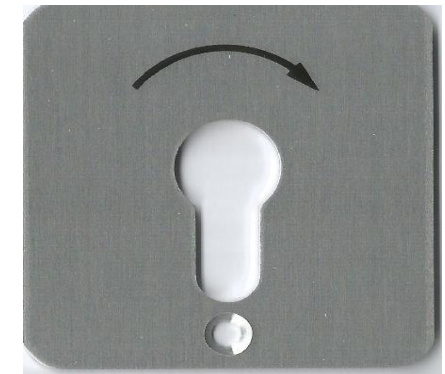

Contact 1202 600.1202.00 2 marche/Arrêt 2 x NO/NF fixe 1 sens

PLASTRON UTILISE

**REPOS**

NO	P1	NF
----	----	----

NF	P	NO
----	---	----

**TRAVAIL**

NF	P1	NO
----	----	----

NO	P	NF
----	---	----

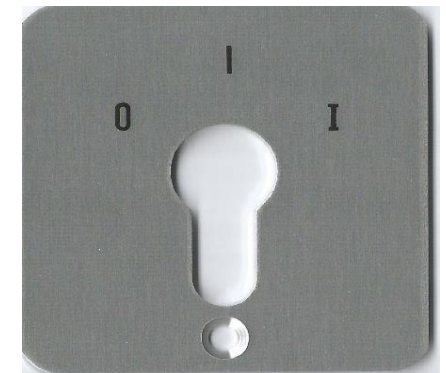
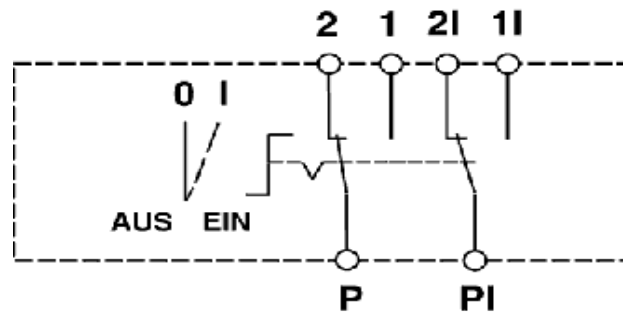

Contact 1301 600.1301.00 2 x contact NO à impulsion 2 sens

REPOS



TRAVAIL  
A GAUCHE



TRAVAIL  
A DROITE



PLASTRON UTILISE

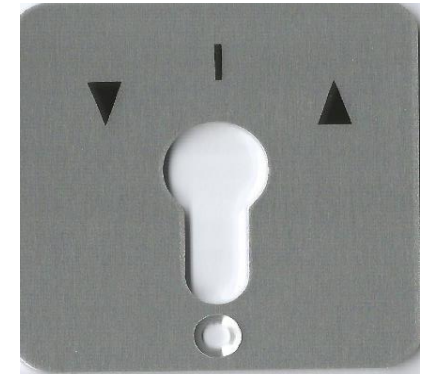

Contact 1302 600.1302.00 2 x 2 contacts NO à impulsion 2 sens

REPOS

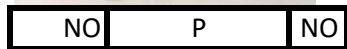

TRAVAIL  
A GAUCHE

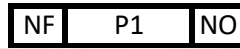

TRAVAIL  
A DROITE

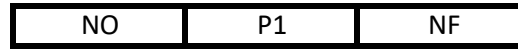

PLASTRON UTILISE

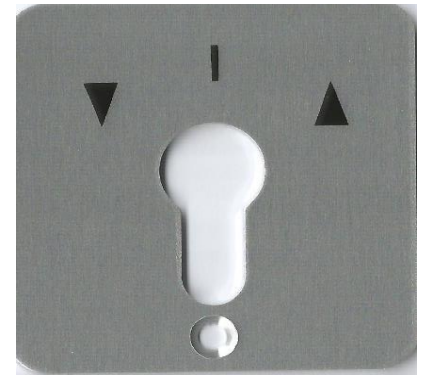

Contact 1402 600.1402.00 2 x 2 contacts NO fixe 2 sens

REPOS

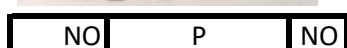

TRAVAIL  
A GAUCHE

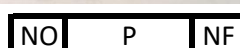
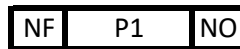

TRAVAIL  
A DROITE

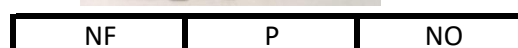
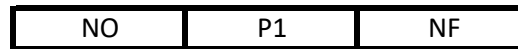

PLASTRON UTILISE

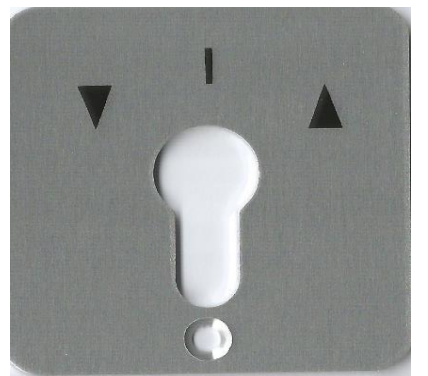

Contact 1502 600.1502.00 2 x 2 contacts NO impulsion à gauche/ Stable à droite

PLASTRON UTILISE

REPOS

TRAVAIL  
A GAUCHE

TRAVAIL  
A DROITE

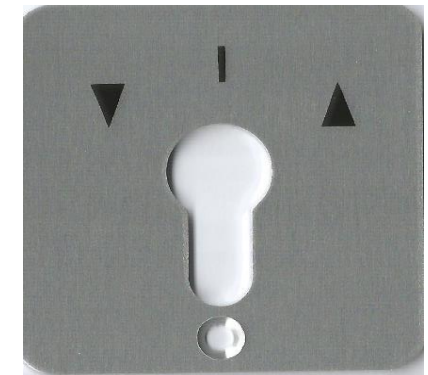
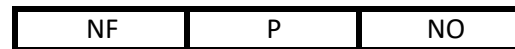
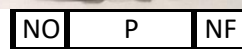
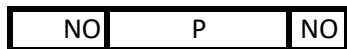
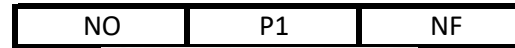
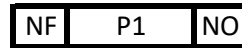

Contact 1602 600.1602.00 1 fois 2 contacts NO et NF à impulsion 1 sens

PLASTRON UTILISE

REPOS

TRAVAIL

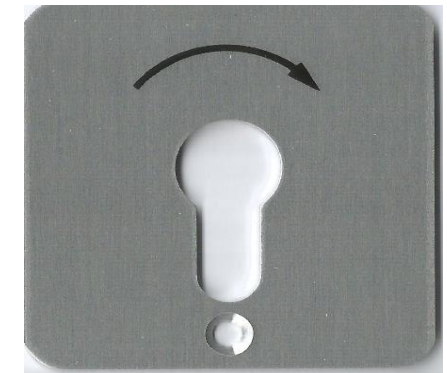
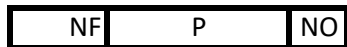
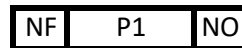
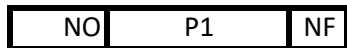

Contact 1802 600.1802.00 2 x 1 contact NO et NF impulsion deux sens

PLASTRON UTILISE

REPOS

TRAVAIL  
A GAUCHE

TRAVAIL  
A DROITE

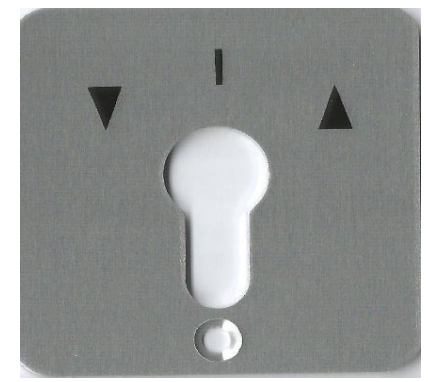
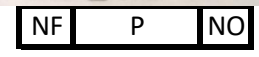
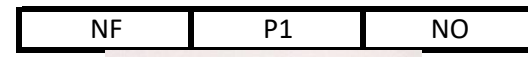
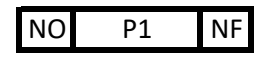
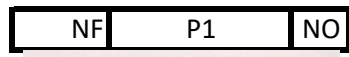

Contact 1902 600.1902.00 2 x 1 contact NO et NF fixe 2 sens

PLASTRON UTILISE

REPOS

TRAVAIL  
A GAUCHE

TRAVAIL  
A DROITE

