

CARACTERISTIQUES

- Colliers en nylon en polyamide 6.6, dentés, pour la fixation de traçages de câbles, tuyaux, conduits et emballage.
- Accessoires disponibles: plaques d'identification, bases adhésives et cheville pour fixation.
- Couleur naturelle, noir ou couleurs.
- Brides détectables : compatibles avec les processus qualité des installations de fabrication des produits alimentaires, conformément aux exigences de la méthodologie HACCP (Hazard Analysis and Critical Control Points).
- Colliers noirs fabriqués avec polyamide et charbon noir: pour applications en extérieur (résistance plus accrue à la radiation ultraviolette).
- Haute résistance aux alcalis, huiles, graisses, dérivés de l'huile, dissolvants chlorés.
- Résistance limitée aux acides.
- Résistance nulle aux phénols.
- Résines sans halogènes
- Selon UNE-EN 62275.
- Colliers agréés suivant l'UL, n°: E343871
- Marquage CE conformément à la directive 2006/95/EC
- Conforme aux réglementations RoHS, PAHs et REACH.



PAHs RoHS

MATÉRIAUX BASE

BN-N/B/VE/MA/AM/ AZ/RO/PL/ID

















TACOBRI B/N/GR



BN-BA

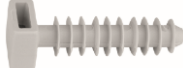

1. GAMME

ITEM	CODE	DIMENSIONS	PHOTO	COULEUR	MATERIEL	CERTIFICAT
1	BN-N	De 2,5 x 80 à 12,5 x 1000 mm		NOIR		 PAHs RoHS
2	BN-B	De 2,5 x 80 à 12,5 x 1000 mm		BLANC		 PAHs RoHS
3	BN-VE	De 2,5 x 100 à 4,8 x 290 mm		VERT		--
4	BN-MA	De 2,5 x 100 à 4,8 x 290 mm		MARRON		--
5	BN-AM	De 2,5 x 100 à 4,8 x 290 mm		JAUNE		--
6	BN-AZ	De 2,5 x 100 à 4,8 x 290 mm		BLEU		--
7	BN-RO	De 2,5 x 100 à 4,8 x 290 mm		ROUGE		--
8	BN-GR	De 2,5 x 100 à 4,8 x 290 mm		GRIS (RAL7035)		--
9	BN-DT	De 2,5 x 100 à 7,6 x 370 mm		BLEU		--
10	BN-ID	De 2,5 x 110 à 2,5 x 210 mm		BLANC		--
11	BN-BA	De 19 x 19 à 27 x 27 mm		BLANC / NOIR		--
12	BN-PL	26,4 x 16,2 mm		BLANC		--
13	TACOBRI B	De Ø6 à Ø8 mm		BLANC		--
14	TACOBRI N	De Ø6 à Ø8 mm		NOIR		--
15	TACOBRI N	De Ø6 à Ø8 mm		GRIS (RAL7035)		--

2. DONNÉES D'INSTALLATION

2.1 BN-N/BN-B

Colliers en nylon blanc et noir



Caractéristiques



PAHs RoHS

Polyamide 6.6

Certification CE et Homologation UL

Données D'installation

CODE		A: Largueur [mm]	B: Longueur [mm]	Diamètre du paquet (mm)	Résistance à la traction ≥ [N]
COLLIER BLANC	COLLIER NOIR				
BB25080	BN25080	2,5	80	3 ÷ 14	79
BB25100	BN25100		100	3 ÷ 20,5	
BB25140	BN25140		140	3 ÷ 33	
BB25160	BN25160		160	3 ÷ 39,8	
BB25200	BN25200		200	3 ÷ 52,5	
BB36140	BN36140	3,6	140	3,5 ÷ 33	178
BB36200	BN36200		200	3,5 ÷ 46	
BB36250*	BN36250*		250	3,5 ÷ 65	
BB36300	BN36300		300	3,5 ÷ 84	
BB36370	BN36370		370	3,5 ÷ 106	
BB48120	BN48120	4,8	120	3,5 ÷ 23,8	218
BB48160	BN48160		160	3,5 ÷ 36,6	
BB48180	BN48180		180	3,5 ÷ 43	
BB48200	BN48200		200	3,5 ÷ 49,5	
BB48250	BN48250		250	3,5 ÷ 65	
BB48290	BN48290		290	3,5 ÷ 78	
BB48370	BN48370		370	3,5 ÷ 100	
BB48430	BN48430	430	3,5 ÷ 122,5		
BB76150	BN76150	7,6	150	8,5 ÷ 35	534
BB76200	BN76200		200	8,5 ÷ 50,9	
BB76290	BN76290		290	8,5 ÷ 79	
BB76370	BN76370		370	8,5 ÷ 103,5	
BB76450	BN76450		450	8,5 ÷ 130,5	
BB76540	BN76540	540	8,5 ÷ 141,59		
BB88770	BN88770	8,8	770	8,5 ÷ 230	779
BB12225	BN12225	12,5	225	8,5 ÷ 57	1200
BB12500	BN12500		500	8,5 ÷ 156	
BB12720	BN12720		720	8,5 ÷ 216	
BB12850	BN12850		850	8,5 ÷ 263	
BB12100	BN12100		1000	8,5 ÷ 315	

PLAN

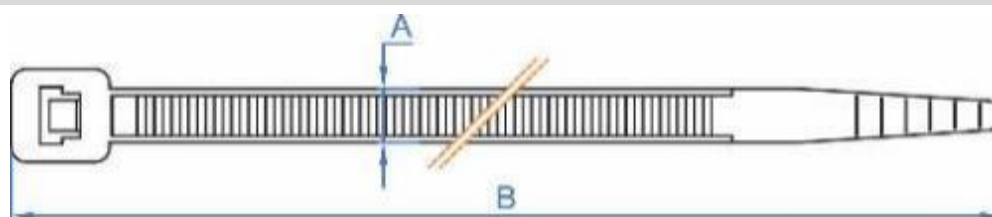

Propriétés de la matière première

Absorption d'humidité	2.5% (23°C, 50% HR)
Température de travail	-40 à +85°C
Température pour l'installation	-10 à +85 °C
Température maximum admise	+110 °C pour une courte période de temps
Température de fusion	+260 °C
Indice limite d'oxygène (LOI):	27 %
Ratio d'inflammabilité	UL94 classe V2
Résistance diélectrique	50.000 voltes/mm
Libre d'halogènes	Oui
Résistance à la radiation UV	colliers de serrage blancs: non colliers de serrage noirs: oui

Exemples D'application

* Non couvert par UL

2.2

BN-VE/MA/AM/AZ/RO/GR

Colliers en nylon différentes couleurs

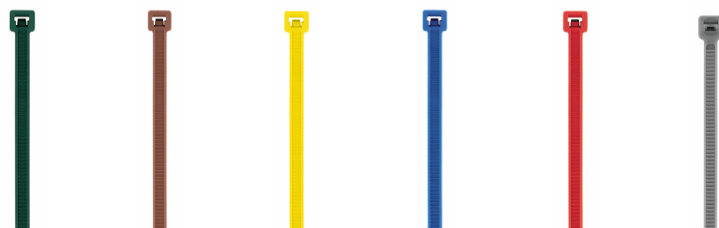

Caractéristiques



Polyamide 6.6

Données D'installation

CODE	Couleur	A: Largueur [mm]	B: Longueur [mm]	Résistance à la traction \geq [N]
BC25100VE	VERT	2,5	100	79
BC36140VE		3,6	140	178
BC36200VE			200	
BC48200VE		4,8	200	218
BC48290VE			290	
BC25100MA	MARRON	2,5	100	79
BC36140MA		3,6	140	178
BC36200MA			200	
BC48200MA		4,8	200	218
BC48290MA			290	
BC25100AM	JAUNE	2,5	100	79
BC36140AM		3,6	140	178
BC36200AM			200	
BC48200AM		4,8	200	218
BC48290AM			290	
BC25100AZ	BLEU	2,5	100	79
BC36140AZ		3,6	140	178
BC36200AZ			200	
BC48200AZ		4,8	200	218
BC48290AZ			290	
BC25100RO	ROUGE	2,5	100	79
BC36140RO		3,6	140	178
BC36200RO			200	
BC48200RO		4,8	200	218
BC48290RO			290	
BC25100GR	GRIS (RAL7035)	2,5	100	79
BC36140GR		3,6	140	178
BC36200GR			200	
BC48200GR		4,8	200	218
BC48290GR			290	

PLAN

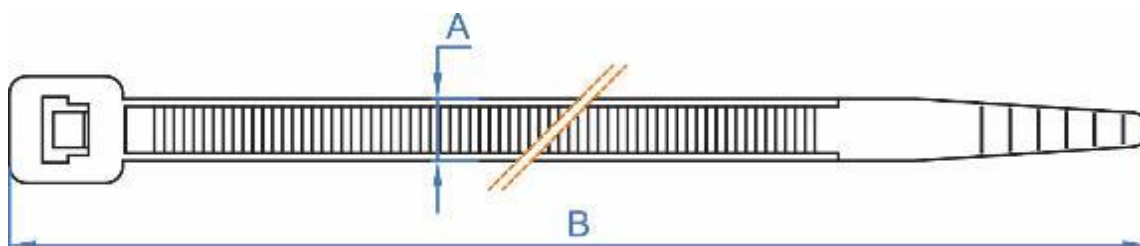

2.3 BN-DT

Colliers en nylon détectables

Caractéristiques



Polyamide 6.6

Données D'installation

CODE	Couleur	A: Largueur [mm]	B: Longueur [mm]	Résistance à la traction \geq [N]
BNDT25100	BLEU	2,5	100	80
BNDT36150		3,6	150	180
BNDT36200			200	
BNDT48200		4,8	200	230
BNDT48300			300	
BNDT48370			370	
BNDT76370		7,6	370	540

PLAN

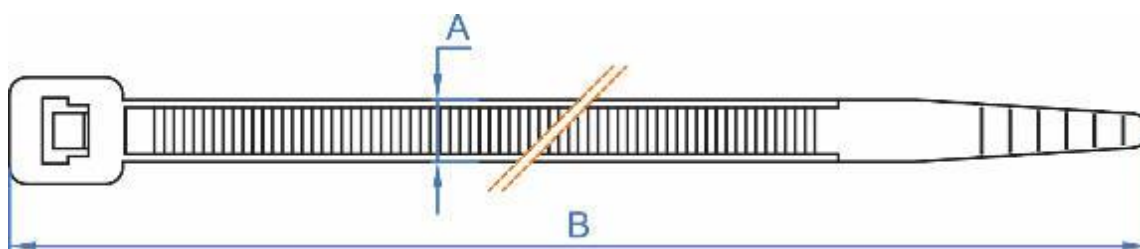

2.4 BN-ID

Collier de serrage en nylon avec identification



Caractéristiques



Polyamide 6.6

Données D'installation

CODE	A: Largeur de collier [mm]	B: Longueur de collier [mm]	C: Largeur d'identification [mm]	D: Longueur d'identification [mm]	TYPE
BID25110	2,5	110	9,2	20,2	A
BID25210		210	8,1	25,1	B

PLAN

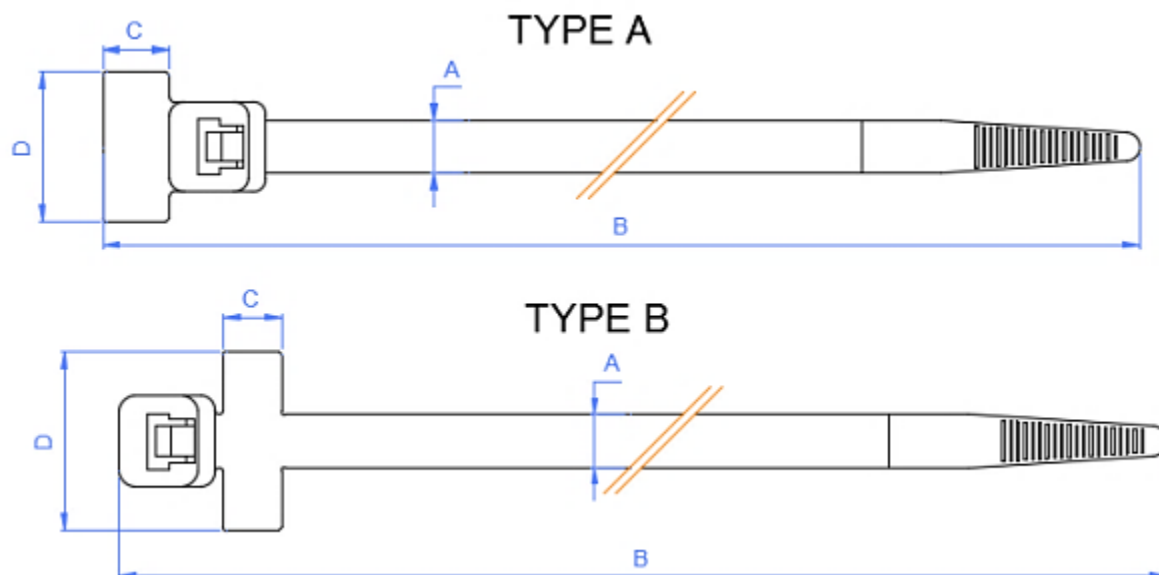

2.5 BN-BA

Base adhésive deux voies, pour collier de serrage en nylon



Caractéristiques



Polyamide 6.6

Données D'installation

CODE	Couleur	A: Largueur de base [mm]	B: Longueur de base [mm]	C: Largueur maximale de collier ≤ [mm]	ØD: Diamètre du foret [mm]	Type
BBANA19	Blanc	19	5	4,8	6,8	A
BBANA27		27,5	5,25	5,2	5,8	B
BBANE19	Noir	19	5	4,8	6,8	A
BBANE27		27,5	5,25	5,2	5,8	B

PLAN

TYPE B

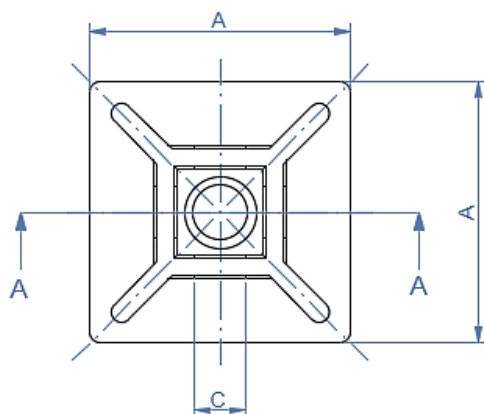

TYPE A

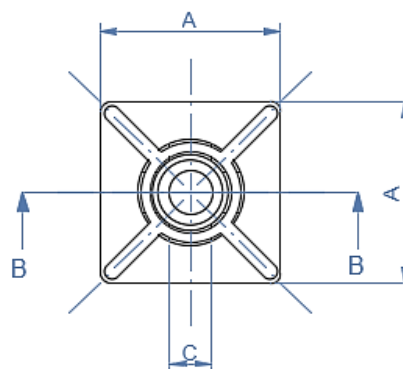

Sección A-A

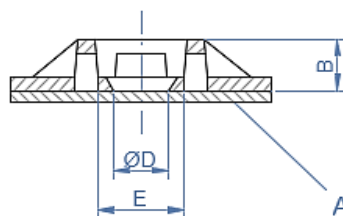

Sección B-B

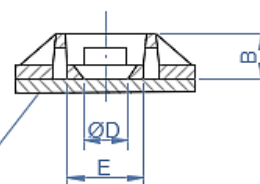

Adhesivo / Adhesive

2.6 BN-PL

Plaque d'identification, pour collier de serrage en nylon



Caractéristiques



Polyamide 6.6

Données D'installation

CODE	A [mm]	B [mm]	C [mm]	D [mm]	E [mm]	F [mm]
BPL02616	26,4	16,2	1	2	2	5

PLAN

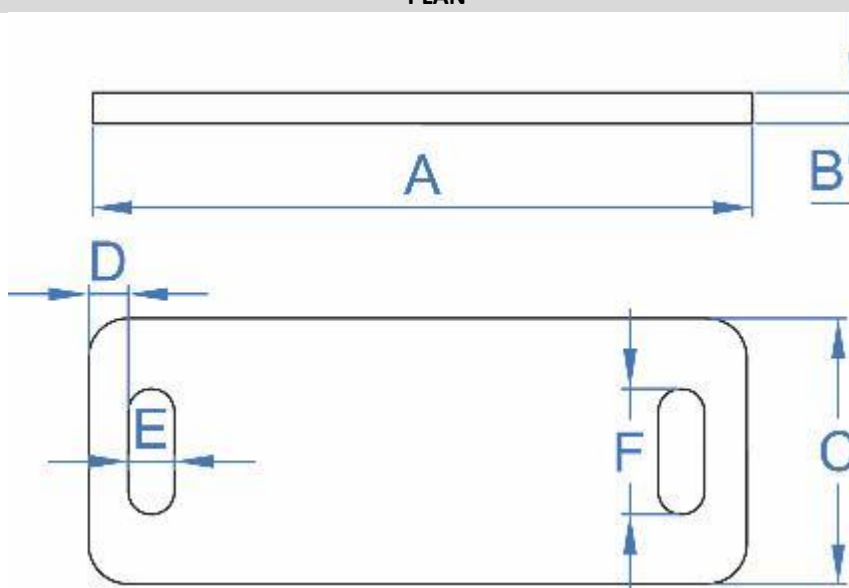

2.7 TACOBRI B/N/GR

Taquet collier



Caractéristiques



Polyamide 6.6

Données D'installation

CODE	Couleur	Ø Diamètre du foret [mm]	Profondeur de forage [mm]	A [mm]	B [mm]	C [mm]	D [mm]	E [mm]	L [mm]
TACOBRI6	Blanc	6	45	12,75	12,75	9,5	3	6	40
TACOBRI8		8							43.5
TACOBRI6	Noir	6							40
TACOBRI8		8							43.5
TACOBRI8	Gris	8							43.5

PLAN

