

Votre distributeur spécialisé :



# Attention !

## Sortie Caisse à outils spéciale Ecoles



Art. 3036

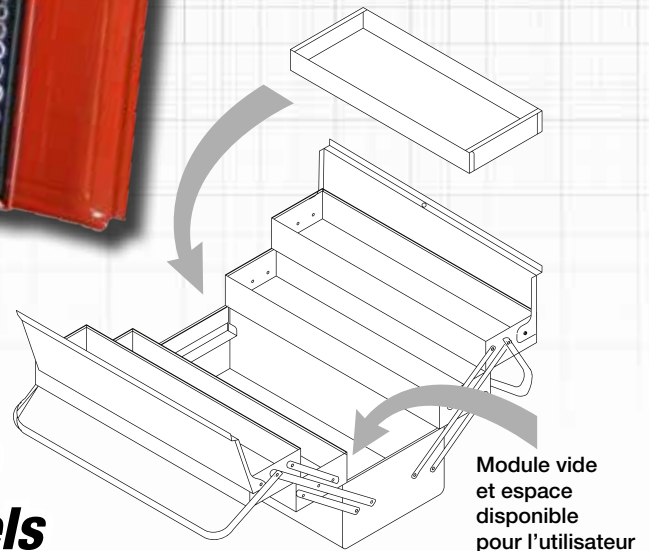









**Composition spéciale et conforme  
aux listes des lycées professionnels**

[www.KRAFTWERKtools.com](http://www.KRAFTWERKtools.com)

# Modules PVC moulés à la forme de chaque outil pour éviter les risques de perte.

## Composition:

Jeu de clés à douilles			3,5-4-5-6-7-8-9-10 11-12-13 mm
			10-13-14-15-16-17-18-19- 21-22-24-27-30-32 mm
Jeu de 10 clés combinées			8-9-10-11-12-13-14-15- 17-19 mm
Jeu de 9 clés TX T10-T50	Art. 3605		T10-T15-T20-T25-T27- T30-T40-T45-T50
Jeu de 9 clés mâles 1.5-10 mm	Art. 3601		1.5-2-2.5-3-4-5- 6-8-10 mm
Tournevis ergokraft avec manches bi-matériaux	Art. 4115-1		PH 1
	Art. 4115-2		PH 2
	Art. 4110-2		0.8 x 4 mm
Art. 4110-3	0.9 x 5 mm		
Tournevis porte-outils universel 1/4"	Art. 4128		
Boîte d'embouts, 33 pcs.	Art. 1789		
Tournevis détecteur de tension 110-250V GS	Art. 2138		
Pince réglable à double crémaillère	Art. 2221-250		250 mm
Cisailles universelles	Art. 2240		150 mm
Pince universelle ergokraft	Art. 3281-180		180 mm
Pince téléphone ergokraft	Art. 3285-200		200 mm
Mètre à rouleau magnétique, 2 côtés	Art. 4700-0316		3 m x 16 mm
Marteau de serrurier	Art. 2303		300 g
Chasse-goupille laqué	Art. 1350-3		3 mm x 125 mm
Pointeau laqué	Art. 1358-2		No. 2 x 120 mm

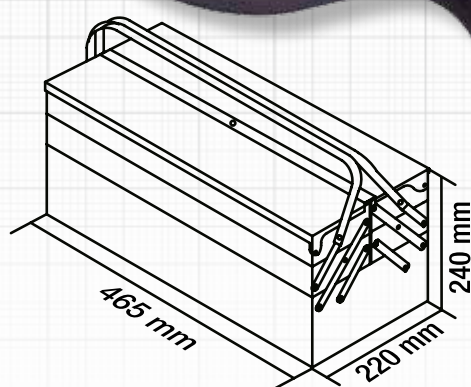
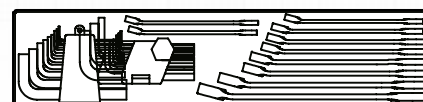
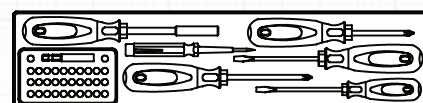
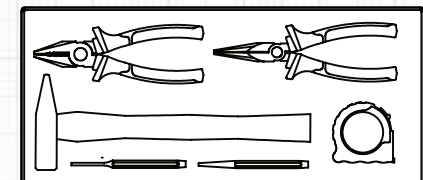
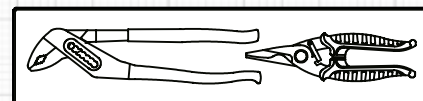
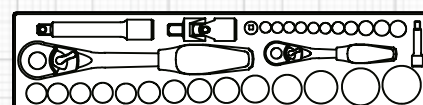

**Des dimensions spécialement adaptées aux armoires vestiaires !**