

DE: Die Wandverbindung enthält keine Schrauben zur Wandfixierung. Diese müssen vom Kunden selbst besorgt werden. Dabei steht die Fixierung zur Wand in der Verantwortung des Kunden. Für eine ungenügende Fixierung aufgrund ungünstiger Schrauben und Dübeln oder instabiler Wandbeschaffenheit wird keine Haftung übernommen.

GB: The wall bracket is not supplied with screws for fastening it to the wall. Customers must supply the screws themselves. Ensuring proper fastening to the wall is the customer's responsibility. No liability is accepted for inadequate fastening due to the use of unsuitable screws and plugs or insufficient stability of the wall.



<http://support.kesseboehmer.de>



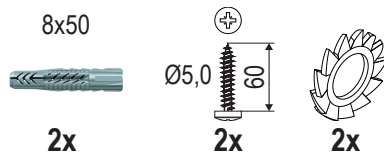
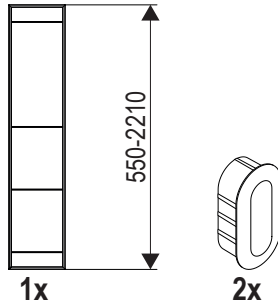
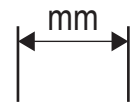

DE Die technischen Darstellungen und Maßangaben – auch bei Abbildungen und Zeichnungen – sind unverbindlich. Konstruktionsverbesserungen sind vorbehalten! **EN** Technical information and stated dimensions (including in illustrations and drawings) must not be regarded as binding. Design subject to improvement without notice! **FR** Les visuels techniques et dimensions – y compris les schémas et les illustrations – ne sont pas contractuelles. Sous réserve d'évolutions techniques! **IT** Le rappresentazioni tecniche e le indicazioni delle dimensioni – anche nelle figure e nei disegni – non sono vincolanti. Con riserva di miglioramenti di progettazione! **ES** Las imágenes técnicas y las indicaciones de medidas – también en imágenes y dibujos – no son vinculantes. Queda reservado el derecho de realizar mejoras en el diseño! **PT** Representações técnicas e dimensões – mesmo em ilustrações e desenhos – não são vinculativas. Reservado o direito a melhorias construtivas! **HE** תוכנית וציורים טכניים אינם מחייבים. שמורה לשיפורים טכניים. **FI** Tekniset piirroksset ja mitat – myös kuvissa ja piirroksissa olevat – ovat sitoumuksetta parantaviin muutoksiin pidätettään! **DA** De tekniske illustrationer og målangivelser - også på illustrationer og tegninger - er ikke bindende. Forbehold for designforbedringer! **CS** Technické popisy a rozměry, jakož i obrázky a výkresy, jsou nezávazné. Vyhrazujeme si právo na změny konstrukce! **PL** Prezentacje techniczne i wymiary – także na ilustracjach i rysunkach – nie są wiążące. Udoskonalenia konstrukcyjne są zastrzeżone! **RU** Иллюстрации технических деталей и указанные размеры, в том числе на рисунках и чертежах, являются ориентировочными. Компания оставляет за собой право на усовершенствование конструкции! **TR** Teknik sunum ve ölçü bilgileri (resim ve çizimlerde de) yasal olarak bağlayıcı değildir. Yapısal geliştirmeler uyarına hakkı saklıdır! **BC** Техническото представяне и размерите, включително при изображенията и чертежите, са необвързващи. Запазваме си правото на конструктивни подобрения! **HU** A műszaki ábrázolások és méretadatok – ábránál és rajzoknál sem – nem kötelező érvényűek. A konstrukciós javítások joga fenntartva! **SR** Tehničke ilustracije i dimenzije - uključujući ilustracije i crteže - nisu obavezujući. Dizajn poboljšanja su rezervisana! **EL** Τα τεχνικά σχέδια και οι διαστάσεις – ακόμα και σε απεικονίσεις και σχέδια – δεν είναι δεσμευτικά. Με την επιφύλαξη τεχνικών βελτιώσεων! **AR** التمثيلات التقنية والبيانات الأبعادية لا تكون ملزمة. يحق إجراء تحسينات تقنية دون إشعار! **JP** 図面は参考資料です。図面に記載の寸法は必ずしも拘束力を持ちません。改良の権利を留保します。 **ZH** 技术说明和规格，包括插图和图纸均不具约束力。保留改进设计的权利！



1

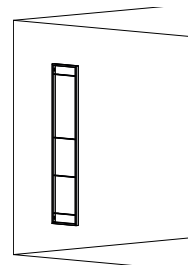
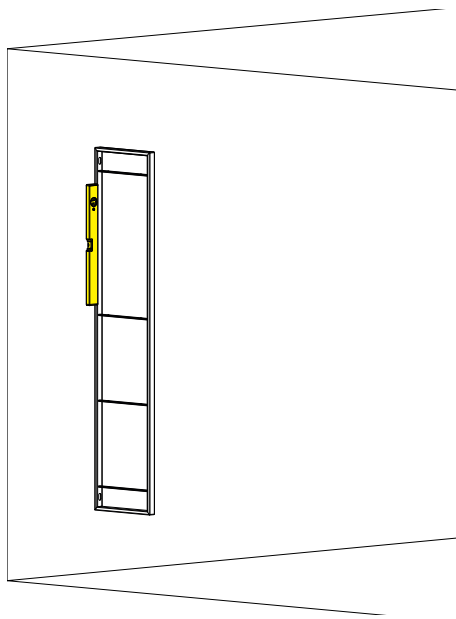
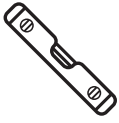

2

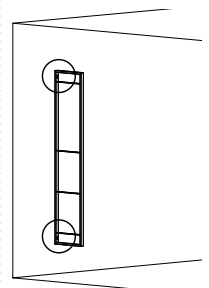
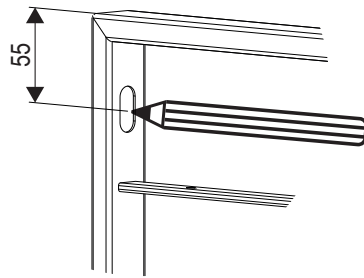

3



8

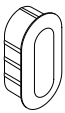

2x

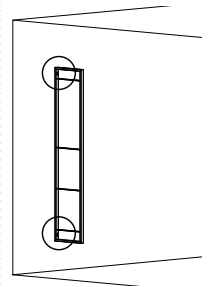
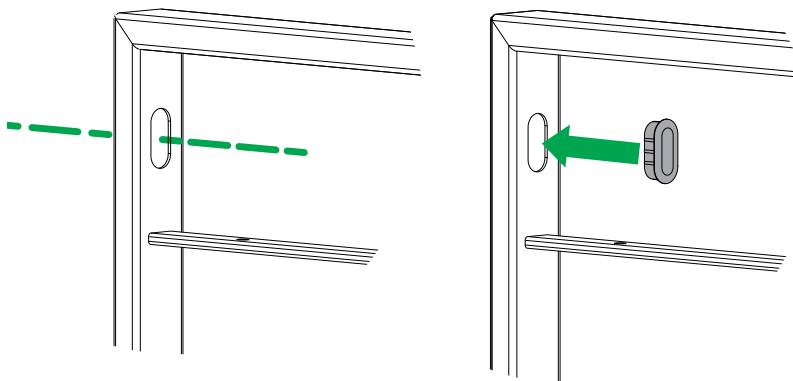
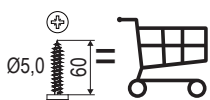
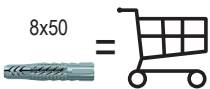



i

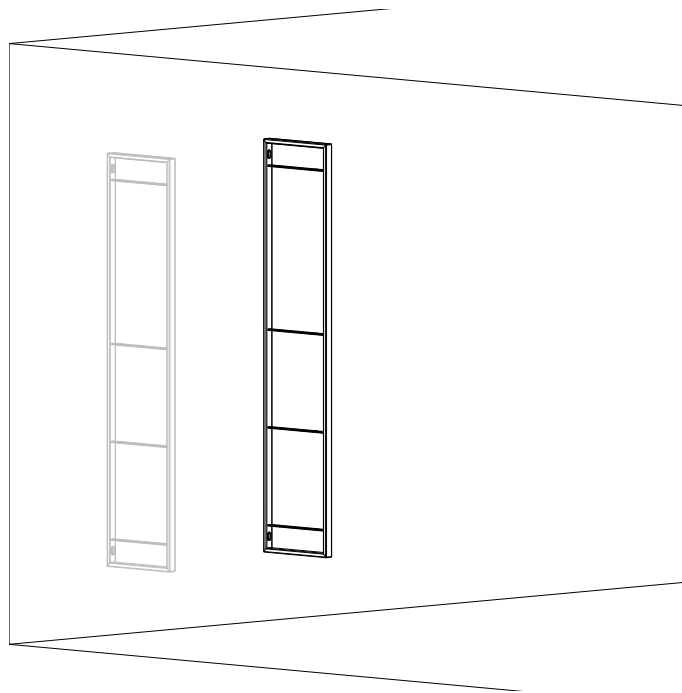
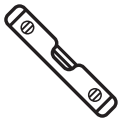

4

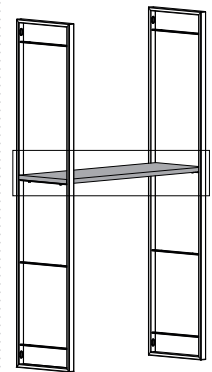
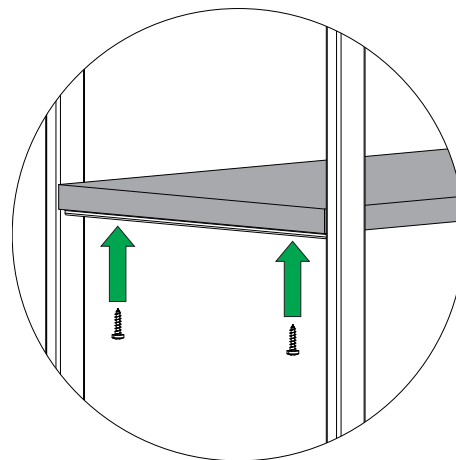
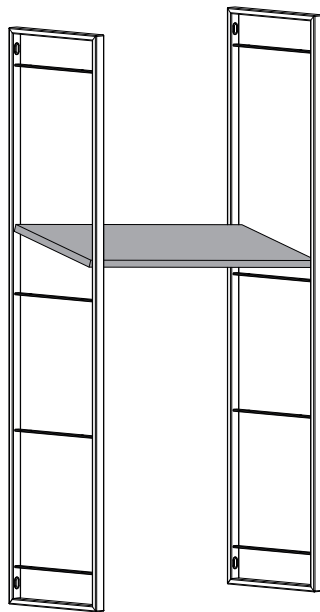

i

