

MONTAGE ARMOIRE A CLES PRINCIPALE

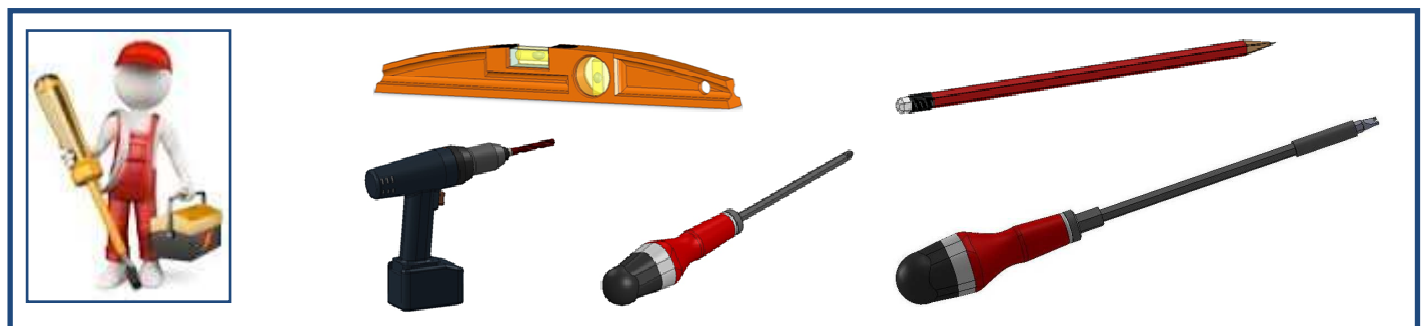

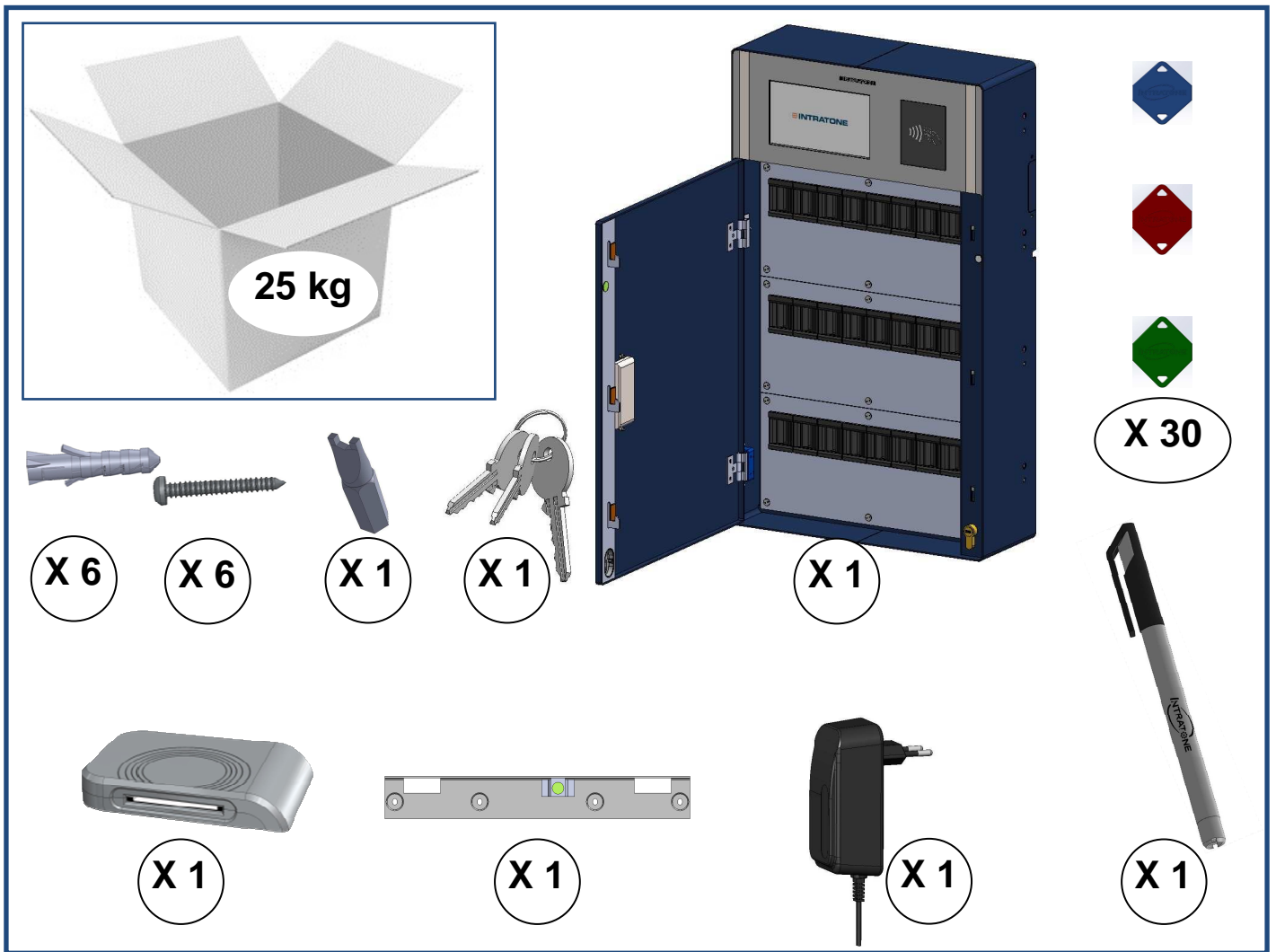

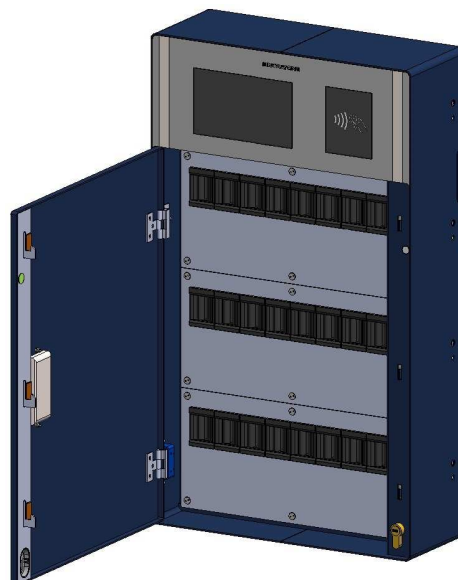
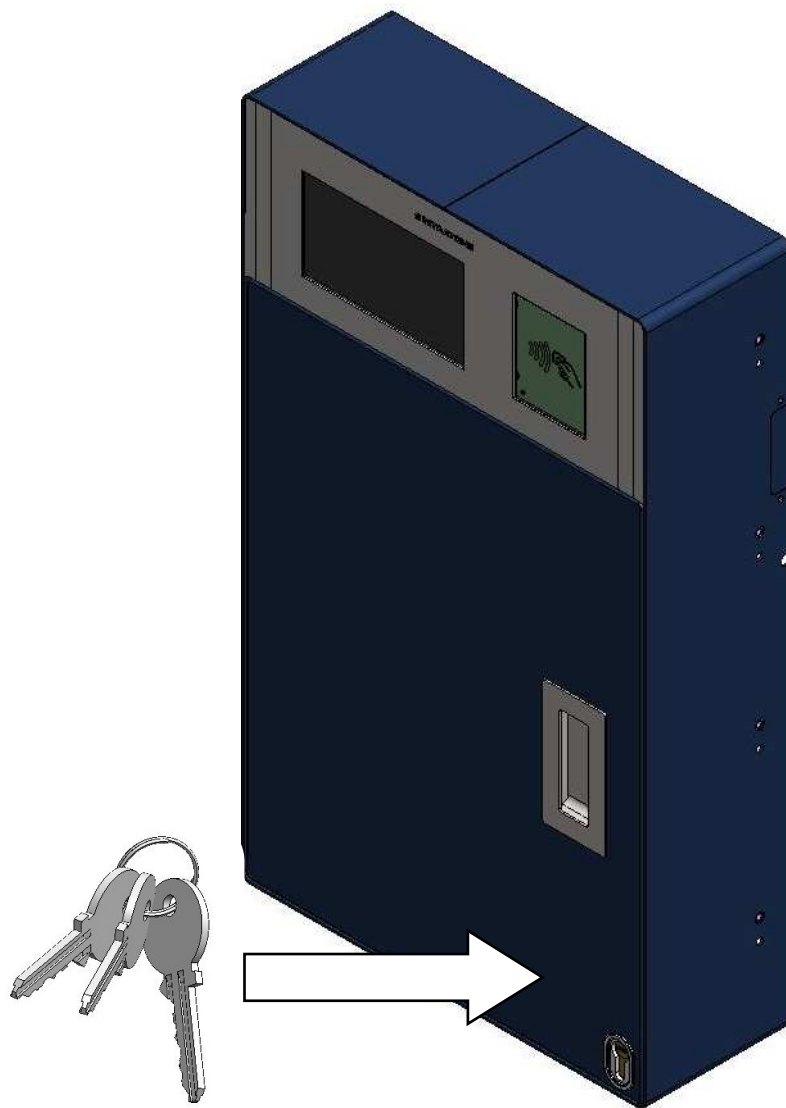
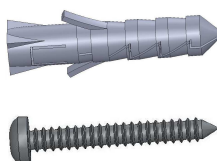
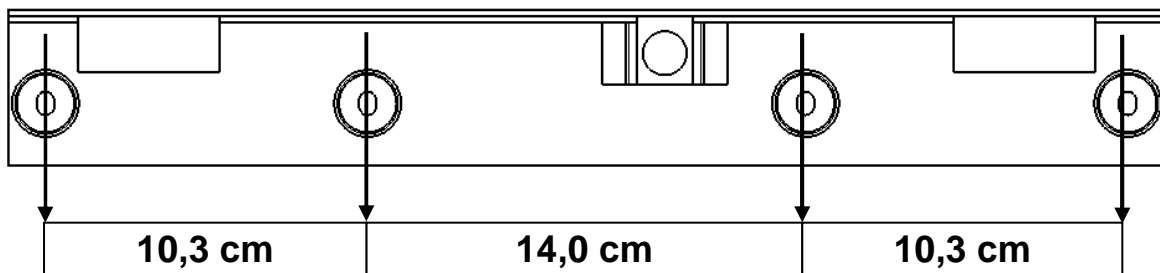
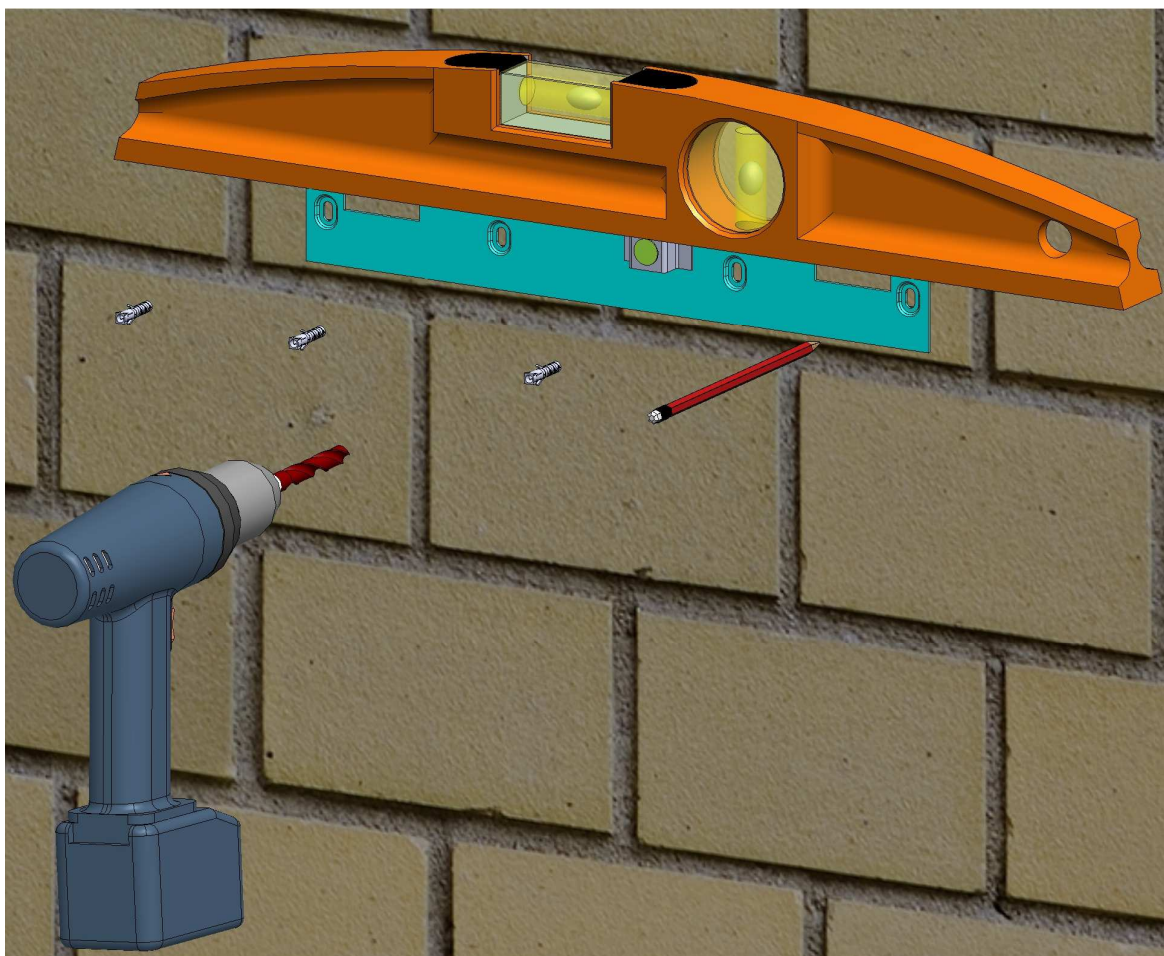

X 4

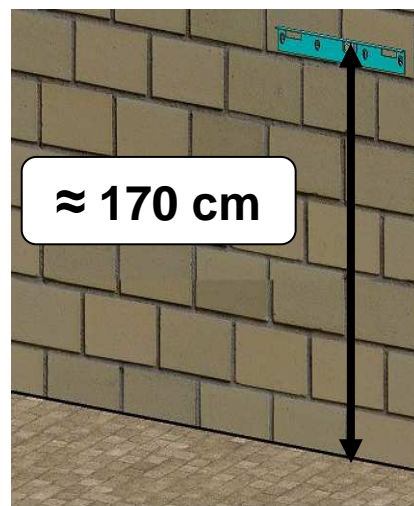
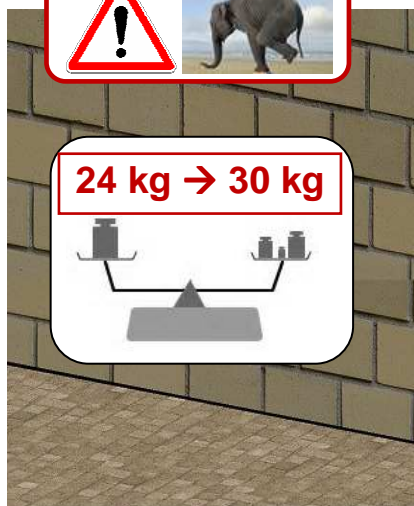
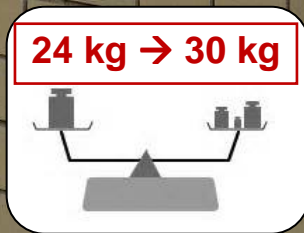

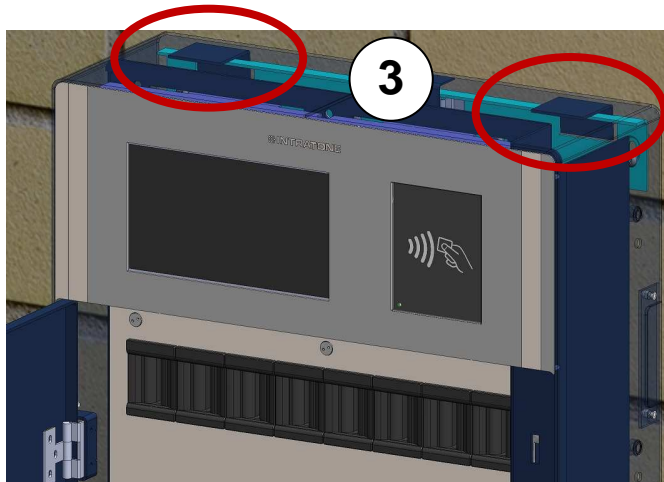
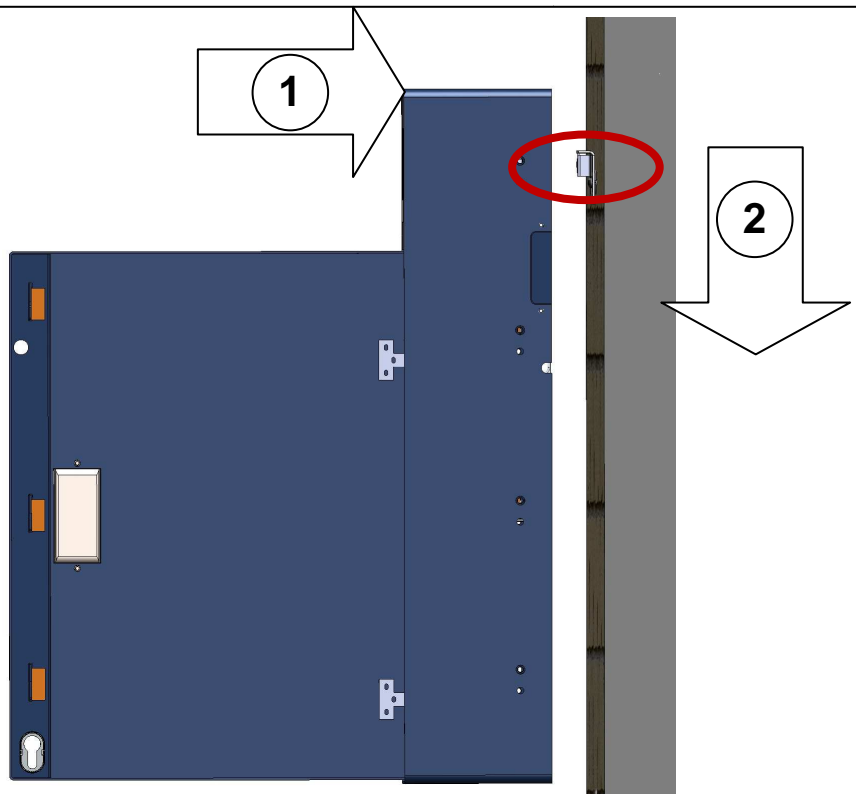

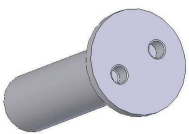
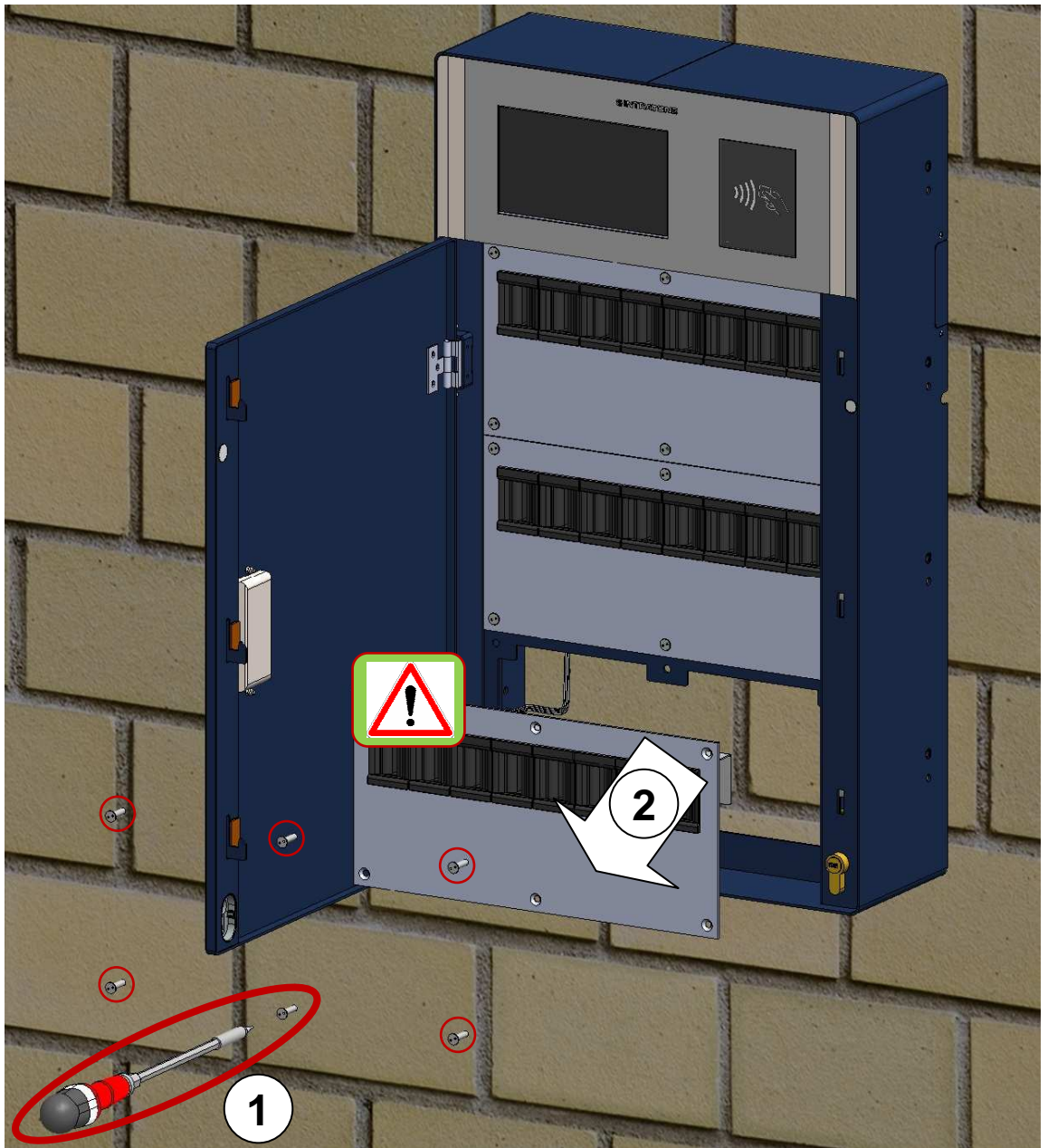

X 6

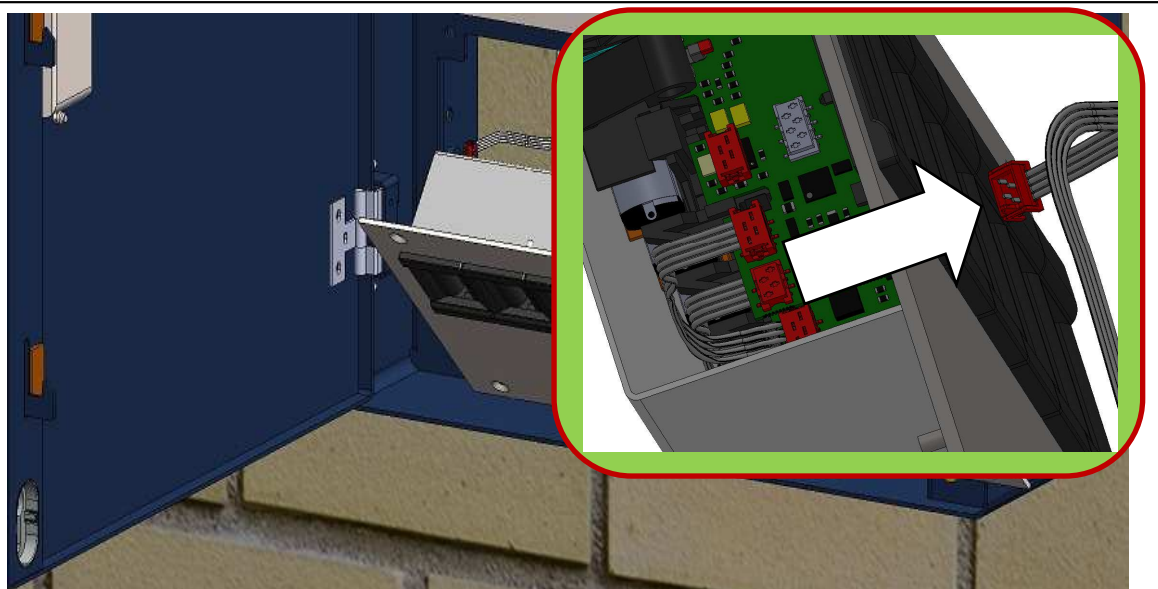

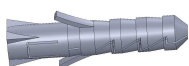
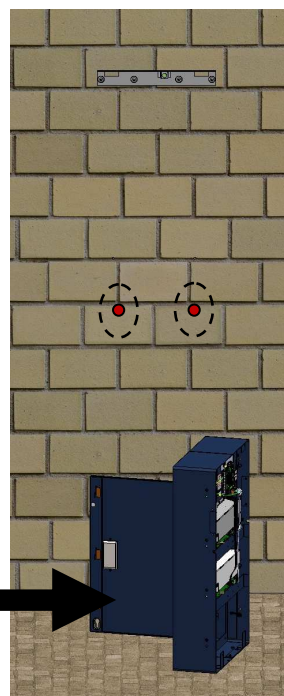
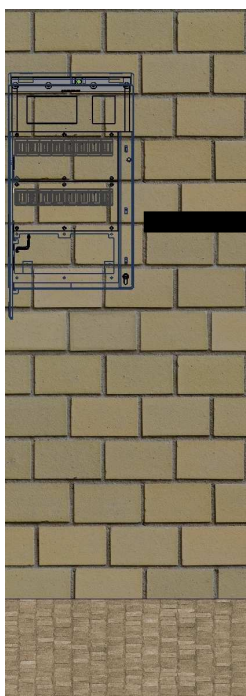
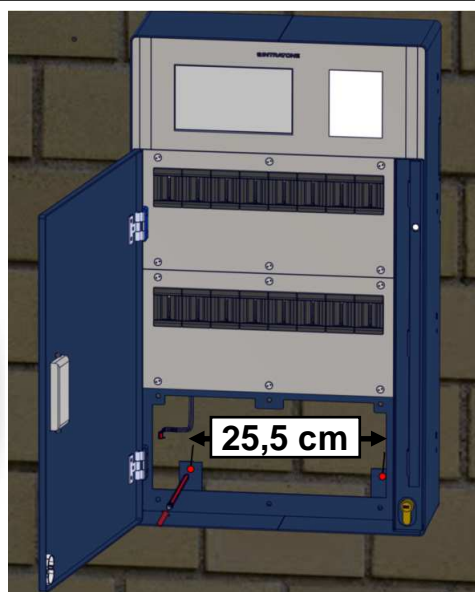
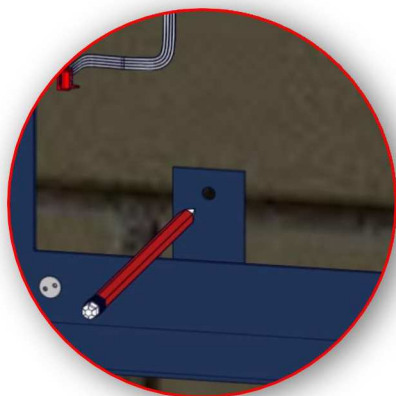

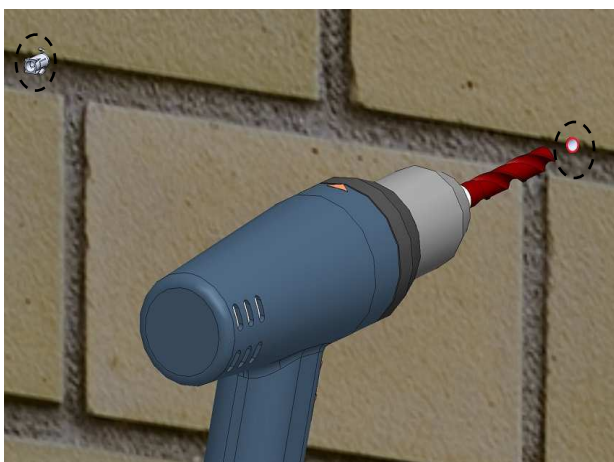

X 2

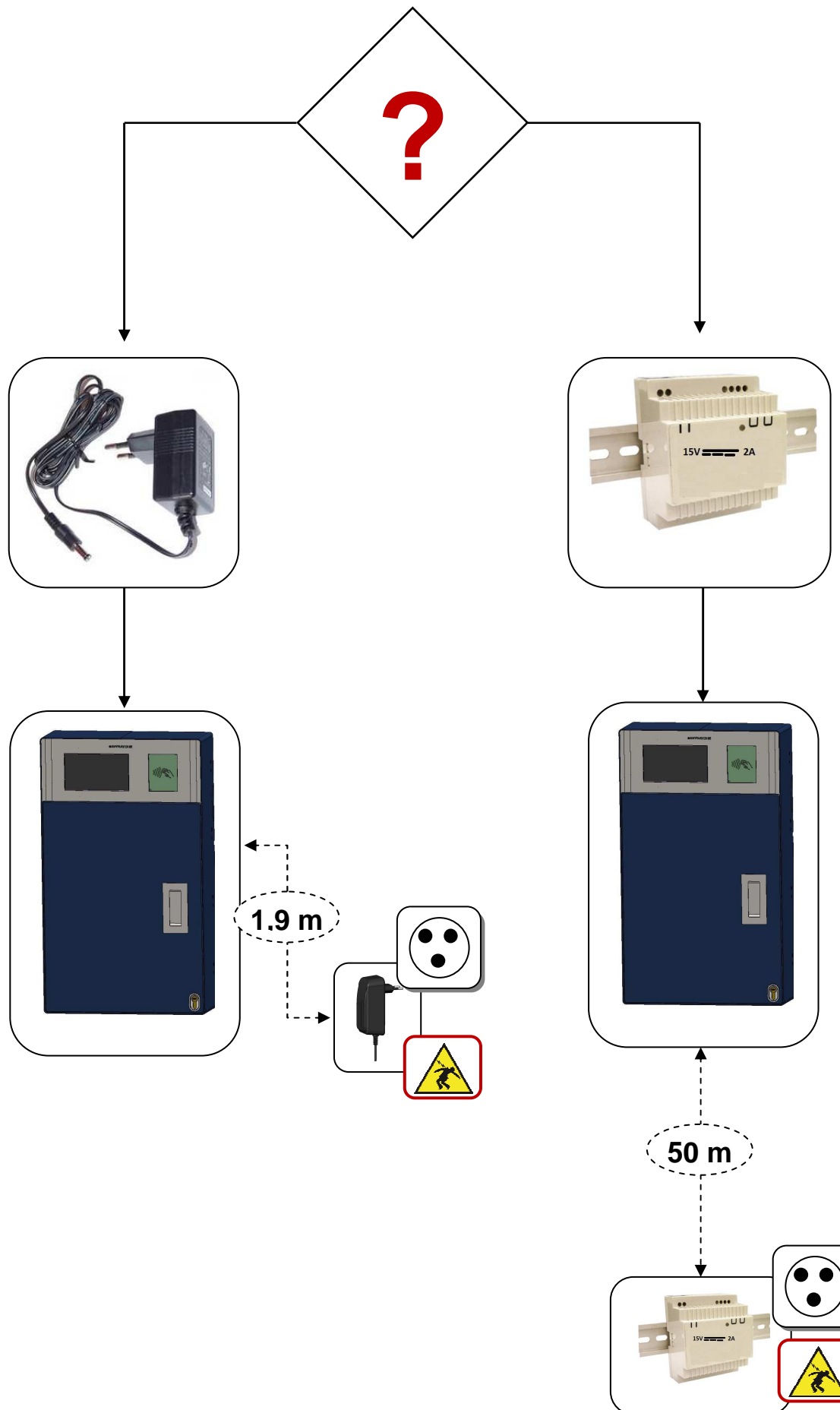

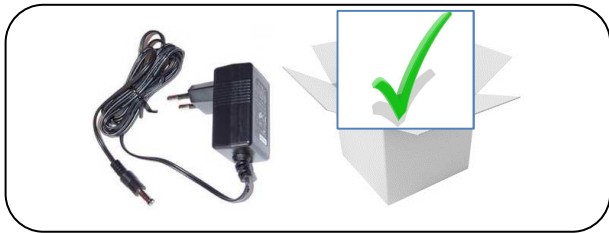



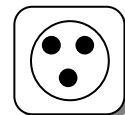
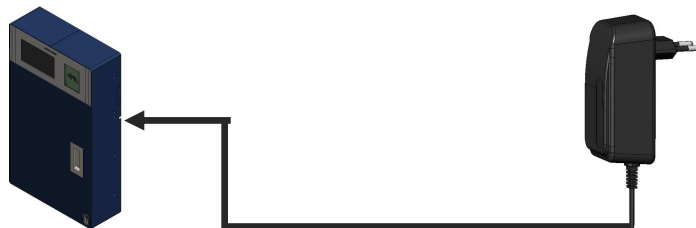
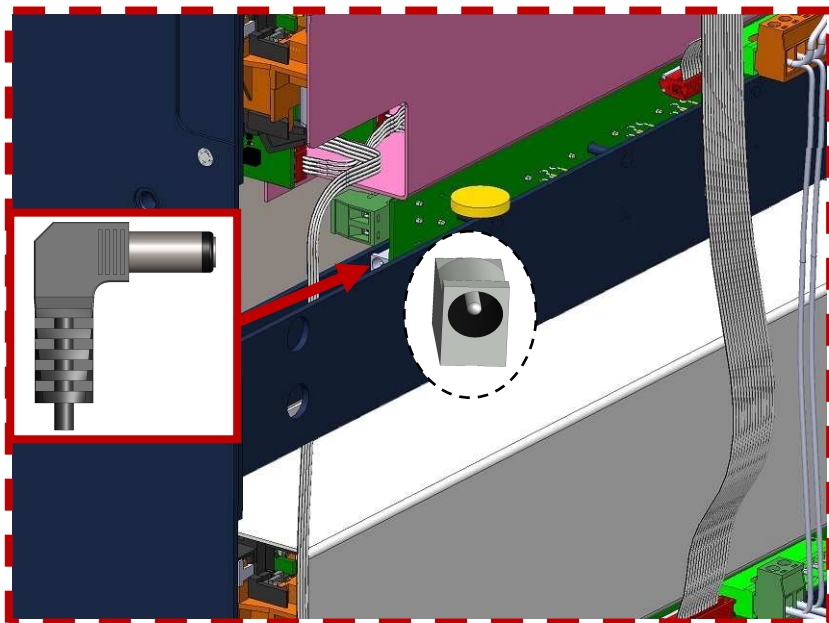
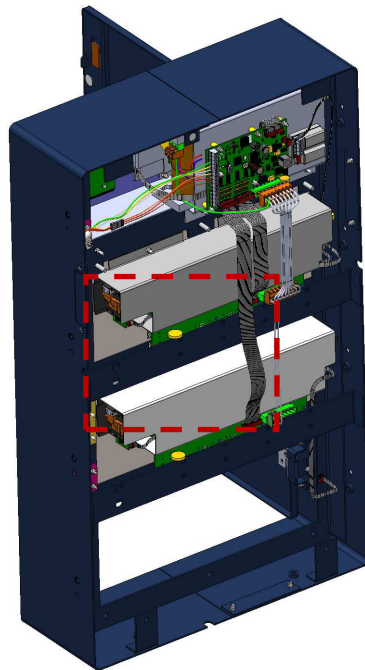

Ø	m
	1,9

15 V DC  / 2 A

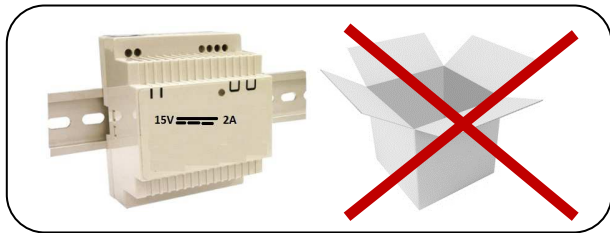



Ø	m
1,5 mm ²	50
15 V DC  / 2 A	

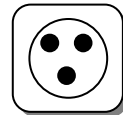
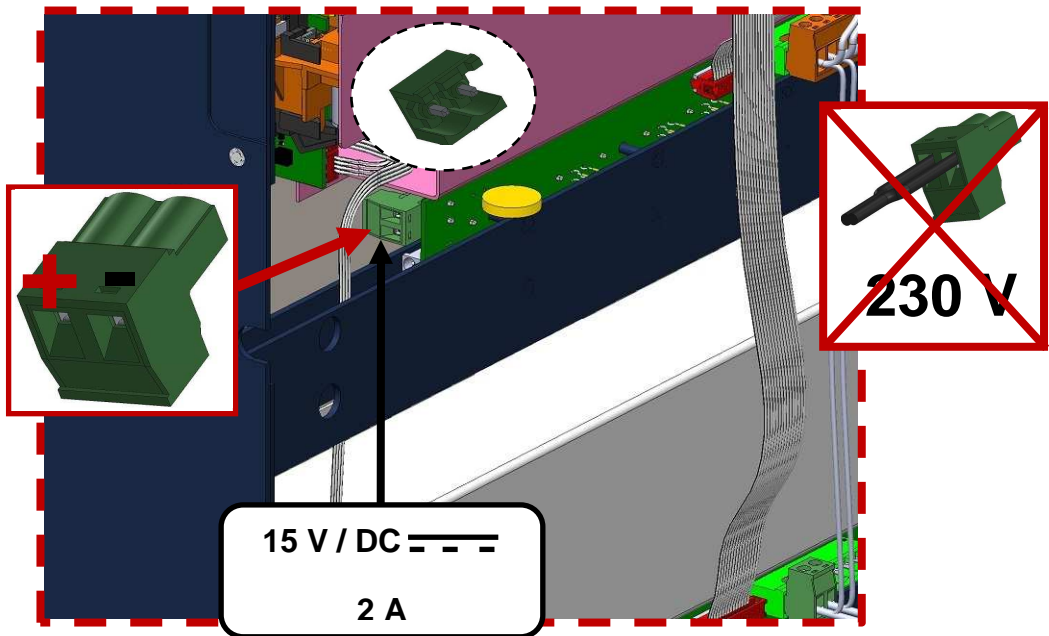
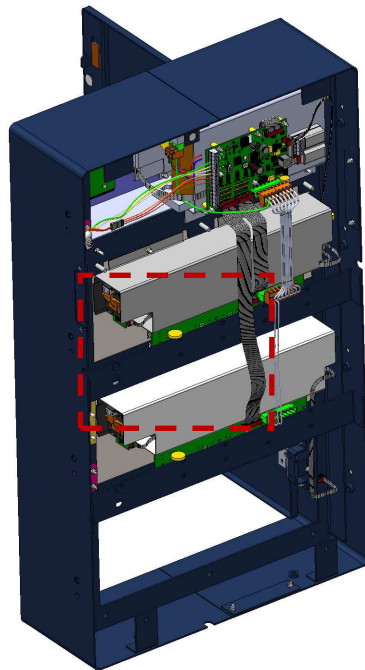

09 / 12 : Fixation de l'armoire au mur

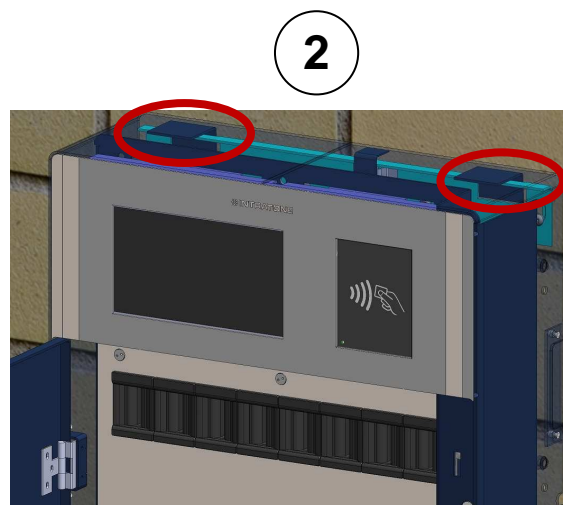
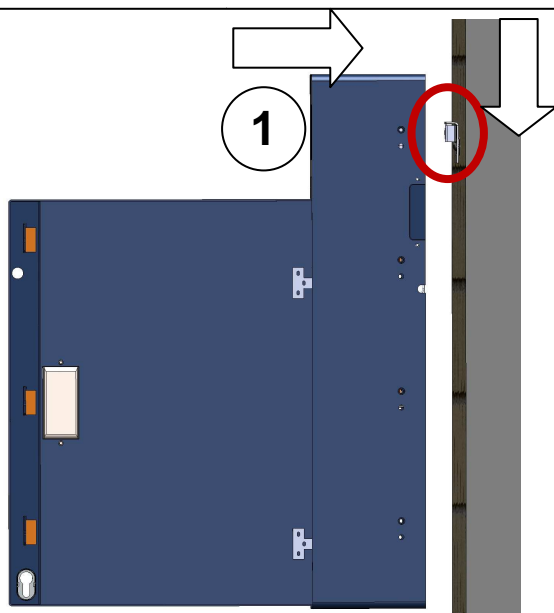

Vue armoire sur le mur ; bandeau du bas vide

3



X 2

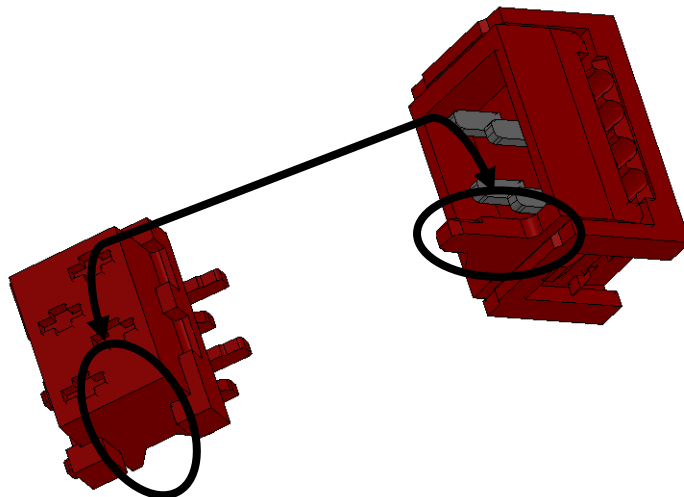
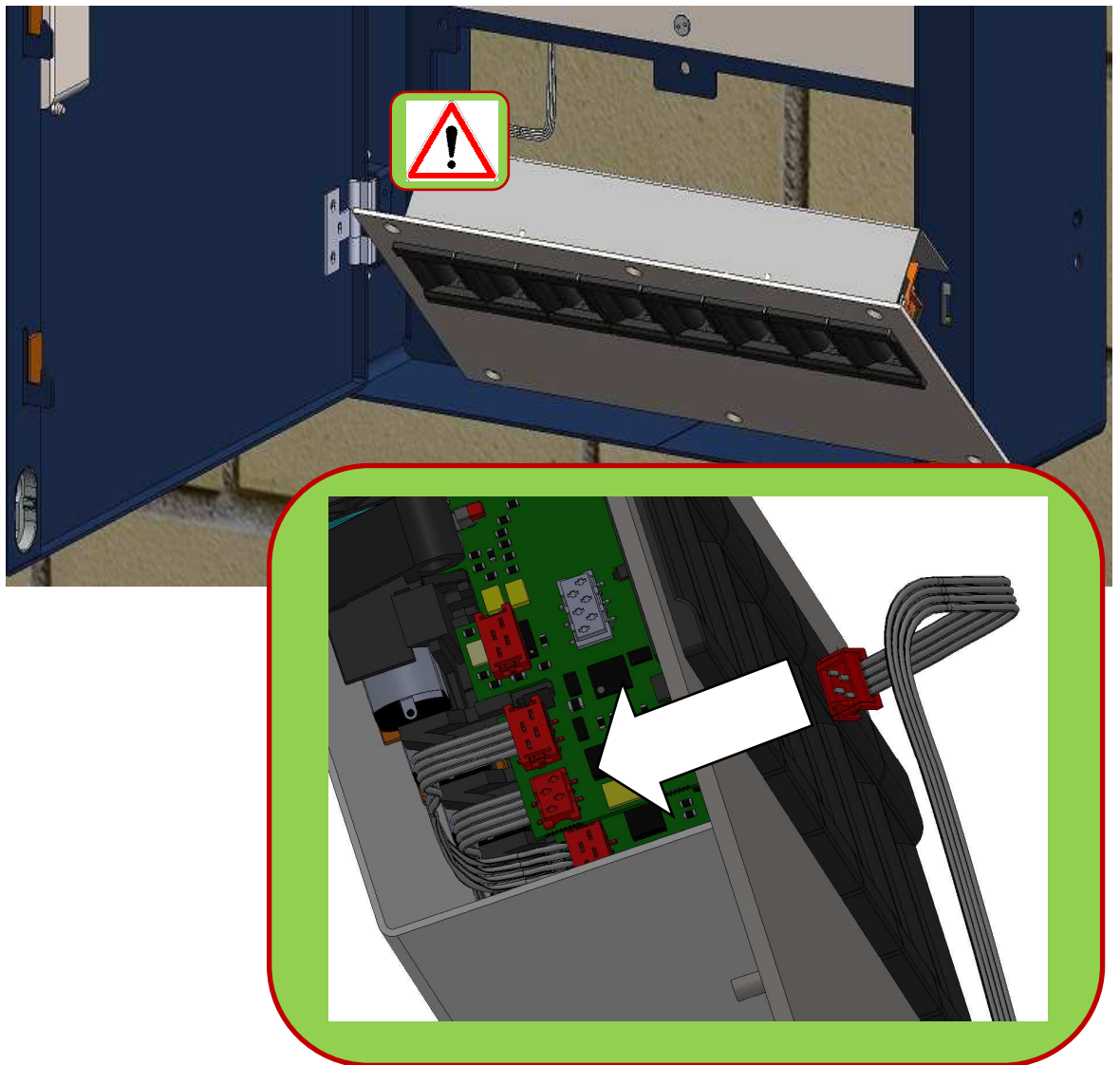

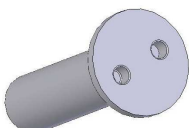
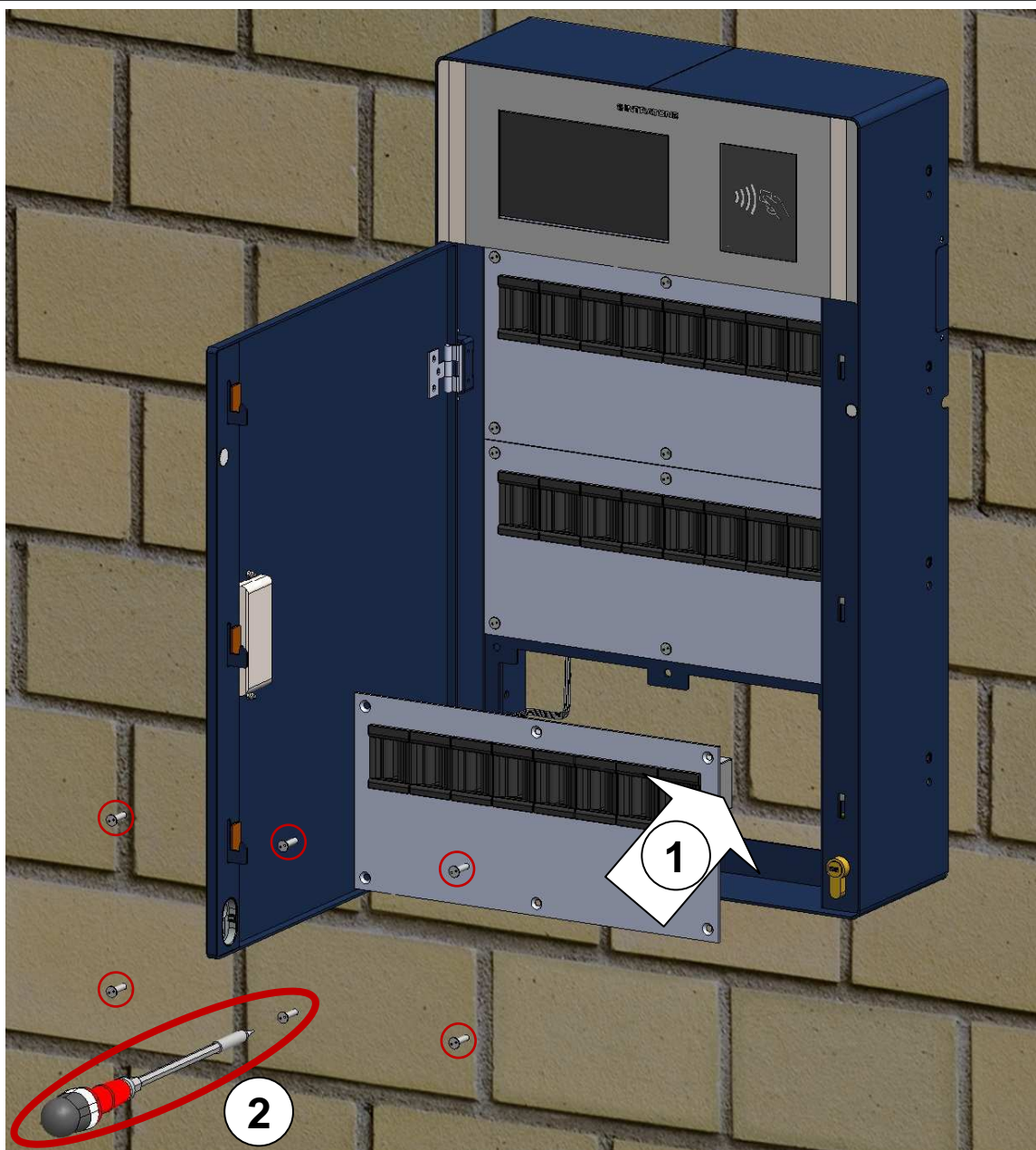
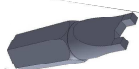

X 6

